

K
RAIN®

SITEMASTER™

2-Wire Decoder Control-



Instruction Manual

TABLE OF CONTENTS

| | | | | | |
|---|-----------|------------------------------------|-----------|---|-------------------|
| Declaration of Conformity Specifications | 02 | Program A Decoder | 19 | Pump Pressurization | 37 |
| Dimensions | 02 | Use Decoder Port | 19 | Save Program | 37 |
| Operating Specifications | 02 | Manually Enter Decoder Number | 20 | Restore Program | 37 |
| Default Settings | 02 | Set Decoder as Master Valve | 21 | Clear Program | 38 |
| Electrical Specifications | 02 | Set Decoder as Pump Start | 21 | Factory Reset | 38 |
| Firmware Version ID | 02 | Sync a Multi-station Decoder | 21 | Set Days Off | 38 |
| SiteMaster Special Features | 03 | Name Zone | 22 | Sensor Configuration | 39 |
| General Introduction | 04 | Remove Zone | 22 | Set Flow Meter Type | 39 |
| Midbox Features | 04 | Reassign a Decoder | 23 | Set Flow Limits | 39 |
| Dial Features | 05 | Programming | 24 | Set Program Limits | 39 |
| Controller Components | 06 | OFF | 24 | Set Zone Limits | 39 |
| Module Fuse Locations | 06 | Auto | 24 | Edit Meter | 40 |
| Line Definition | 07 | Set Program Start Times | 24 | Volume Counts | 40 |
| Main Fuse Locations | 07 | Set Watering Days | 25 | Clear Total Volume | 40 |
| Keyboard Layout | 08 | Set Weekdays | 25 | Clear Daily Volume | 40 |
| Basic Decoder Installation | 09 | Set Odd Days | 25 | Possible Flow Sensor Error Messages | 41 |
| Single Station Decoder Installation | 09 | Set Even Days | 26 | Set Weather Station | 41 |
| 2-Station Decoder Installation | 10 | Set Cycle Days | 26 | Weather Data | 42 |
| 4-Station Decoder Installation | 11 | Set Zone Run Times | 27 | ET Data | 42 |
| Basic Surge Protector Installation | 12 | Run Single Zone/System Test | 28 | ET Base Line | 42 |
| Grounding Specifications | 13 | Single Zone Test | 28 | ET Programs | 42 |
| Controller Grounding | 13 | Decoder LED Test | 29 | WS Connection | 43 |
| Decoder/Surge Protector Grounding | 13 | Full Test | 29 | Reset ET | 43 |
| Installation | 14 | No Coil Test | 30 | Reset Rain | 43 |
| Door Removal | 14 | Energize 2-Wire | 30 | Connecting a Wireless Rain Sensor | 44 |
| Main Panel Removal | 14 | Special Features | 31 | Learn | 44 |
| Mounting the Controller | 15 | Seasonal Adjust | 31 | Status | 44 |
| Powering the Controller | 15 | By Program | 31 | Program Disable | 45 |
| Controller Configuration | 16 | Set For All | 31 | WR Connection | 45 |
| Set Date | 16 | Zone Grouping | 32 | Program Display | 45 |
| Set Time | 16 | Create a New Group | 32 | Decoder Status | 46 |
| Set Imperial/Metric | 17 | Edit Group | 32 | General Log - Fault Log | 46 |
| Set 12/24 Hour Clock | 17 | Display Group | 33 | Decoder Status Check | 47 |
| Name Program | 17 | Delete Group | 33 | View Status | 47 |
| Display Current | 18 | Maximum Distance Graphs | 33 | Fault List | 48 |
| Display Flow | 18 | Maximum Distance Chart, 12 AWG | 34 | 2-Wire Module Status Light Definitions | 49 |
| | | Maximum Distance Chart, 14 AWG | 35 | Pump Start Relay/ Master Valve Wiring | 49 |
| | | Delay/Overlap | 36 | Rain Sensor Installation | 49 |
| | | By Zone | 36 | Remote Programming | 50 |
| | | Set For All | 36 | Network Module Configuration | 51 |
| | | MV/PS Zone Set-up | 37 | Warranty | Back Cover |

DECLARATION OF CONFORMITY

This unit has been designed to provide reasonable protection against harmful interference in a residential install.

This equipment uses, generates and can radiate radio frequency energy and, if not installed and used in accordance with the instructions, may cause harmful interference to radio communications. There is no guarantee that interference will not occur in any particular install.

If the equipment does cause harmful interference to radio or television reception, which can be determined by turning the equipment off and back on again, the user is encouraged to try to correct the interference by:

- (1) reorient or relocate the receiving antenna;
- (2) increase the separation between the equipment and receiver;
- (3) connect the equipment into an outlet on a different circuit from the receiver;
- (4) consult the dealer or an experienced radio / TV technician for help.

Changes or modifications to this equipment could void the warranty.

SPECIFICATIONS

DIMENSIONS

- Width: 15.45" / Height 11.91" / Depth 6.43"
- Width 39.24 cm / Height 30.25 cm / Depth 16.33 cm

OPERATING SPECIFICATIONS

- Station Run Times: 1 second to 9:59:59 Programs A, B, C, D, E, & F
- Start Times: 6 per program
- Watering Schedule: 7 Day Calendar (any day of the week) odd or even days, interval watering up to 31 days.
- Operating Temperature: 0° - 140°F (18° - 60° C)
- Zone Capacity: 99
Zone groups limited to 6 zones and 1 MV/PS per primary line (A and B total) for a total of 12 zones
- Pump Start requirements:
Pump Start relays hard-wired to the provided locations on the SiteMaster controller will require the use of a K-Rain 1520 or 1510 Mini Coil relay. Remote Pump Start relays running with a decoder on the 2-wire path require a K-Rain 3410 Optical Relay at each location. Coil voltage rating of 120V or 240V only. See optical relay manual for installation guide.

DEFAULT SETTINGS

- The SiteMaster controller has non-volatile memory that retains all programming data even during power outages and without the need for any battery back-up. Batteries are used for time and calendar accuracy and 9V is used for remote programming when the main panel is removed from the cabinet.

ELECTRICAL SPECIFICATIONS

- 2-wire transformer
Input: 120/240 VAC 50/60 Hz
Max Output: 27 VAC 100VA 3.7 AMP
- Midbox Transformer
Input: 120/240 VAC 50/60 Hz
Max Output: 24 VAC 40VA 1.71 AMP
- Battery:
- 2032 Coin Cell (included)
- 9V alkaline battery (optional) (not included)
- For PERMANENTLY CONNECTED EQUIPMENT, a readily accessible disconnect device shall be incorporated external to the equipment.

FIRMWARE VERSION ID

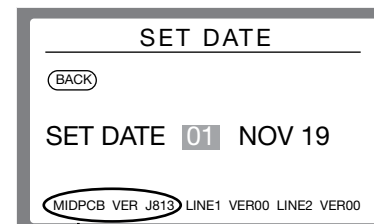

Displays the version of firmware installed.

SITEMASTER SPECIAL FEATURES

- Up to 99 zones
- Dual transformer design for additional lightning protection
- 6 separate programs
- 6 start times per program
- 2 independent (hard wired) pump start and master valve terminals and 3 additional Decoder MV/PS
- Terminals provided for 2 hard wired flow meters, plus additional 3 decoder flow meters
- Easily name zones and entire programs
- Hard wired terminals dedicated to rain sensor, as well as functions with a K-Rain wireless rain sensor
- Moisture sensors on decoders
- Zone grouping
- Will run 12 zones simultaneously along with MV/PS (6 per line only)
- Ability to run a Decoder status any time that will display: zone, line, outgoing signal strength, incoming signal strength.
- Ability to energize a line (or both) to test current load
- Interactive fault log to keep track of resolved/unresolved issues
- Terminals for weather station. Weather station will adjust run times based on ET.
- Configure controller to imperial or metric
- Configure clock to either 12 hr. or 24 hr.
- 4 separate wire paths, on 2 independent lines
- GSM capable
- Set Hrs./minutes to Minutes/Seconds by Program. Hrs./Minutes default
- Coin cell battery in the midbox to support non-volatile battery. No AAA batteries.
- 9V optional for remote programming.
- Decoders available in: 1 zone, 2 zone, 4 zone

GENERAL INTRODUCTION

MIDBOX FEATURES

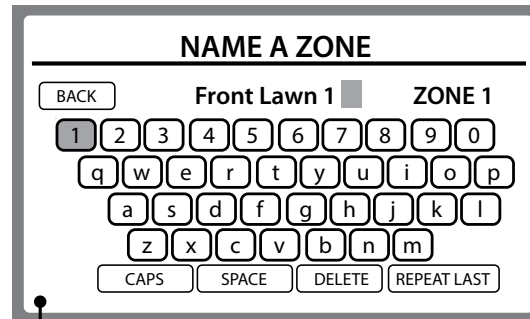
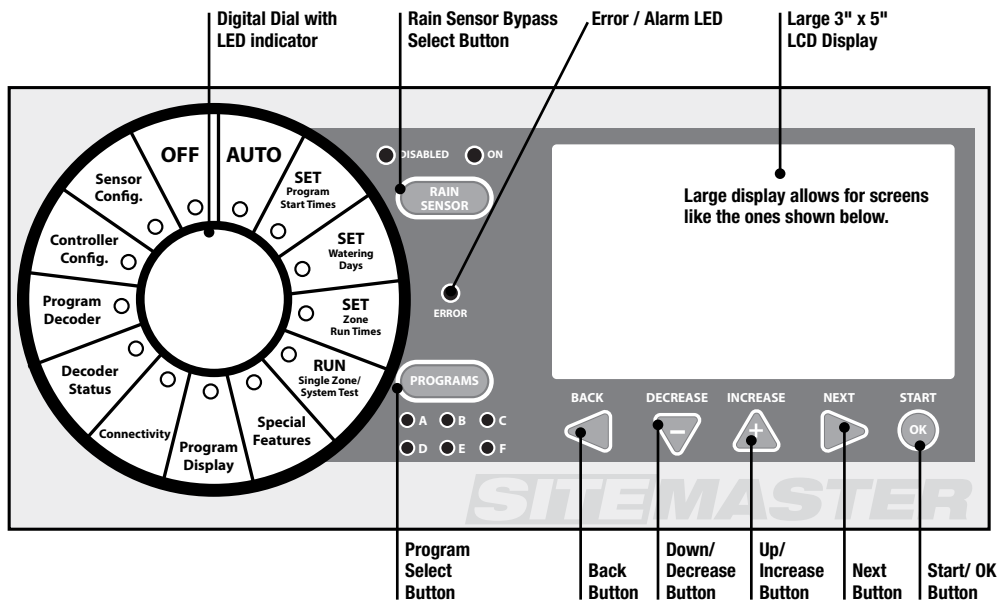

Full keyboard controlled by either the directional arrows and/or the dial.

Program A

| | | | | | | | | | | |
|-----------|----|----|----|----|----|----|----|----|----|----|
| Monday | 1 | 2 | 3 | 4 | 5 | 6 | 7 | 8 | 9 | 10 |
| Tuesday | 11 | 12 | 13 | 14 | 15 | 16 | 17 | 18 | 19 | 20 |
| Wednesday | 21 | 22 | 23 | 24 | 25 | 26 | 27 | 28 | 29 | 30 |
| Thursday | 31 | 32 | 33 | 34 | 35 | 36 | 37 | 38 | 39 | 40 |
| Friday | 41 | 42 | 43 | 44 | 45 | 46 | 47 | 48 | 49 | 50 |
| Saturday | 51 | 52 | 53 | 54 | 55 | 56 | 57 | 58 | 59 | 60 |
| Sunday | | | | | | | | | | |

of Start Times scheduled - 6 First start time 8:00 am

Program Display

Shows:

- Days of the week used
- Zones assigned to a program
- Zones missing run times
- Number of start times
- Time of first start

GENERAL INTRODUCTION

DIAL FEATURES

- ↪ Set Controller Date/Time
- ↪ Standard/Metric
- ↪ 24hr/12hr
- ↪ Name Program
- ↪ Display Current Load
- ↪ Display Live Flow Data
- ↪ Special Options

- ↪ Initialize any decoder type; assign to a zone or task
- ↪ Name individual zones
- ↪ Add/remove zones
- ↪ Reassign Decoder

- ↪ Check/update a separate fault log
- ↪ Check a total general log
- ↪ Run/view decoder status check

- ↪ GSM/cellular set up

- ↪ Flow Meter Type
- ↪ Set Flow Limits
- ↪ Volume Counts
- ↪ Set Weather Station
- ↪ Set Moisture Sensors
- ↪ Set Wireless Rain Sensor

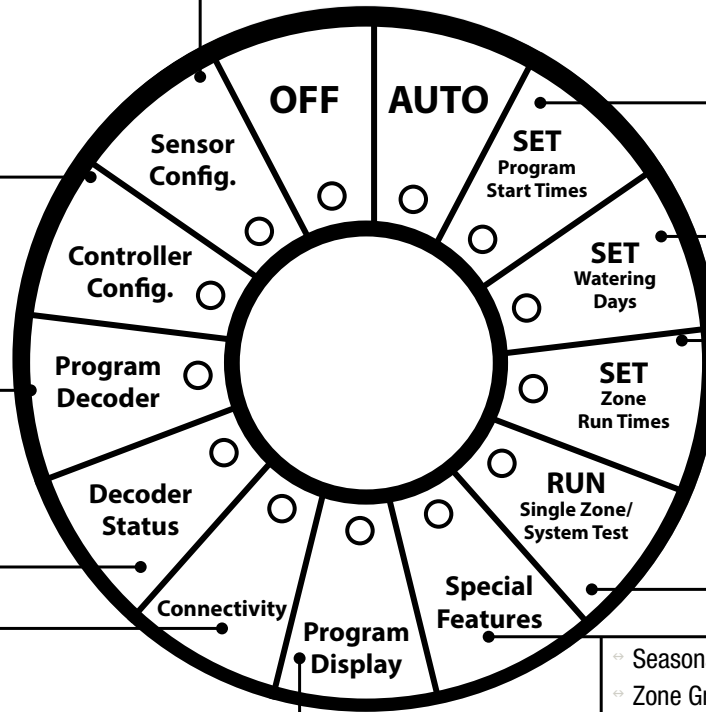

Set 6 separate start times for each of the 6 programs

Set watering days; set odd/even watering days, add cycle day setting.

Set individual zone run times / durations

- ↪ Run a single zone test
- ↪ Decoder Test
- ↪ Timed full system test
- ↪ No Coil Test
- ↪ Energize the 2-wire path to run electrical tests

The display will show an entire program on one screen

- ↪ Seasonal Adjust
- ↪ Zone Group
- ↪ Zone Delay/Overlap
- ↪ Set MVPS
- ↪ Clear Program
- ↪ Save Program
- ↪ Restore Program
- ↪ Permanent Days Off

GENERAL INTRODUCTION

CONTROLLER COMPONENTS

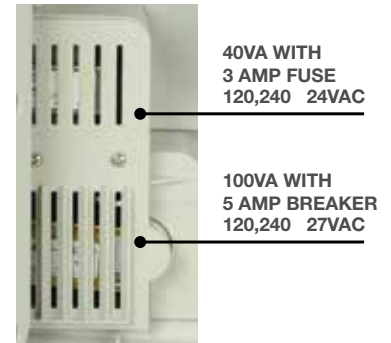
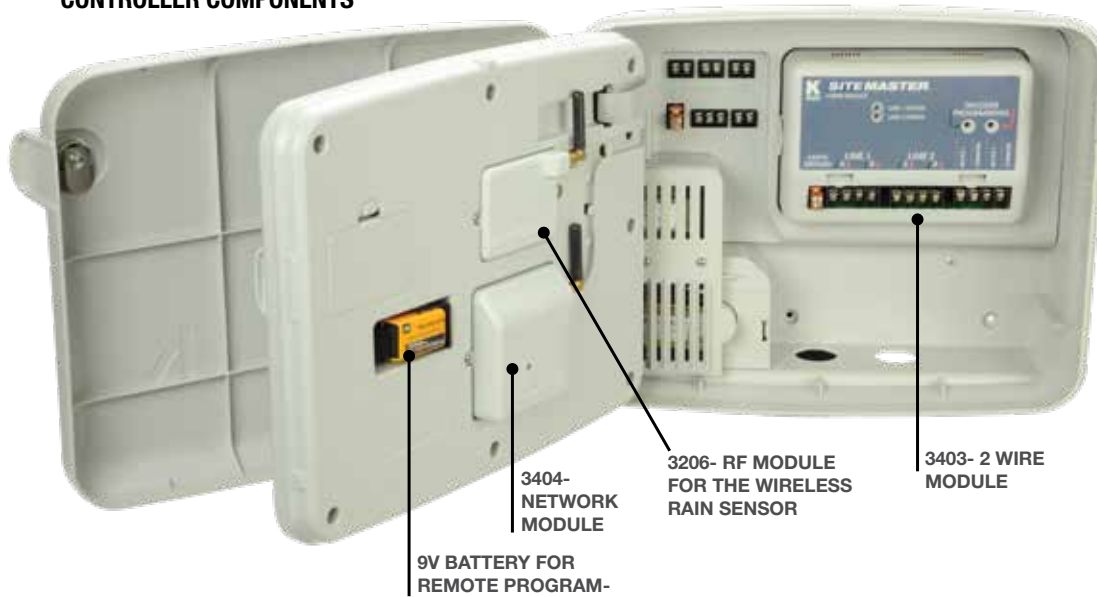

MODULE FUSE LOCATIONS



GENERAL INTRODUCTION

LINE DEFINITION

The SiteMaster features 4 total wire paths from 2 independent sources:
Line 1 – A & B, Line 2 – A & B.

To make wiring easy, use the color coded arrows when installing 2-wire line. **NOTE:** Do this when using the Programming Port as well.

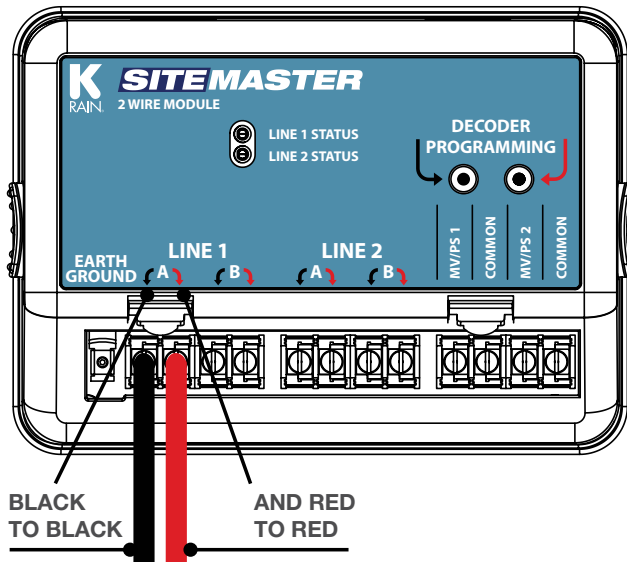

MAIN FUSE LOCATIONS



FUSE COVER



ACCESS TO THE TRANSFORMER SECONDARY FUSES

GENERAL INTRODUCTION

KEYBOARD LAYOUT

When using the on-screen keyboard, use the ◀▼▶ arrows OR the dial, navigate the cursor around the keyboard to highlight the desired letter or number, then push OK. Then scroll the cursor to NEXT and push the ▶ arrow to confirm the name change.

Use this key to REPEAT a letter

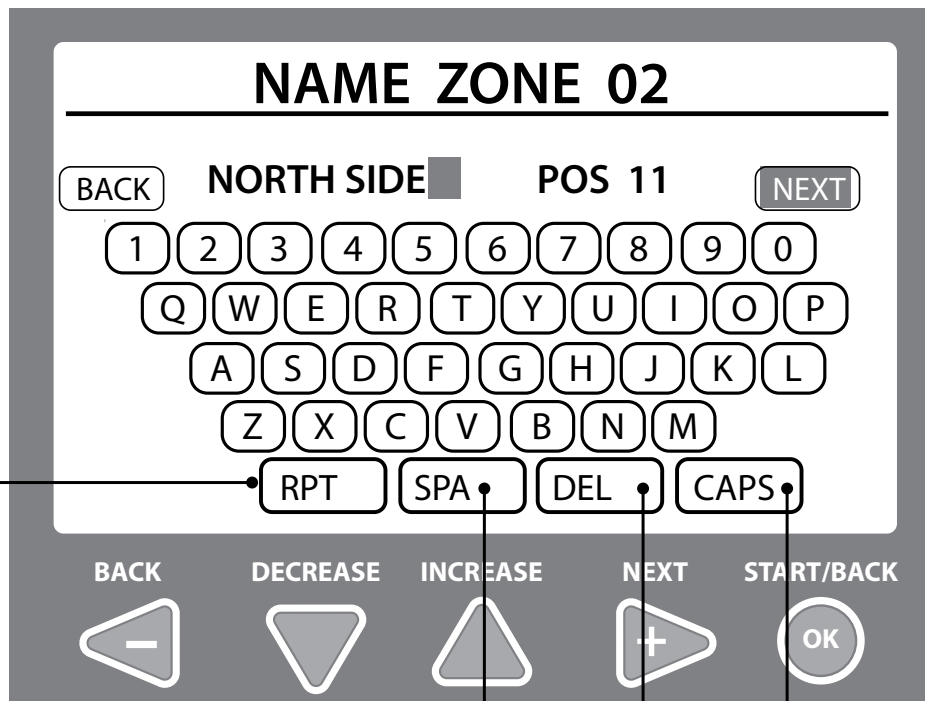

This is a
SPACE bar

This is a
DELETE key

This key changes your
letters to capitals

BASIC DECODER INSTALLATION

SINGLE STATION DECODER INSTALLATION

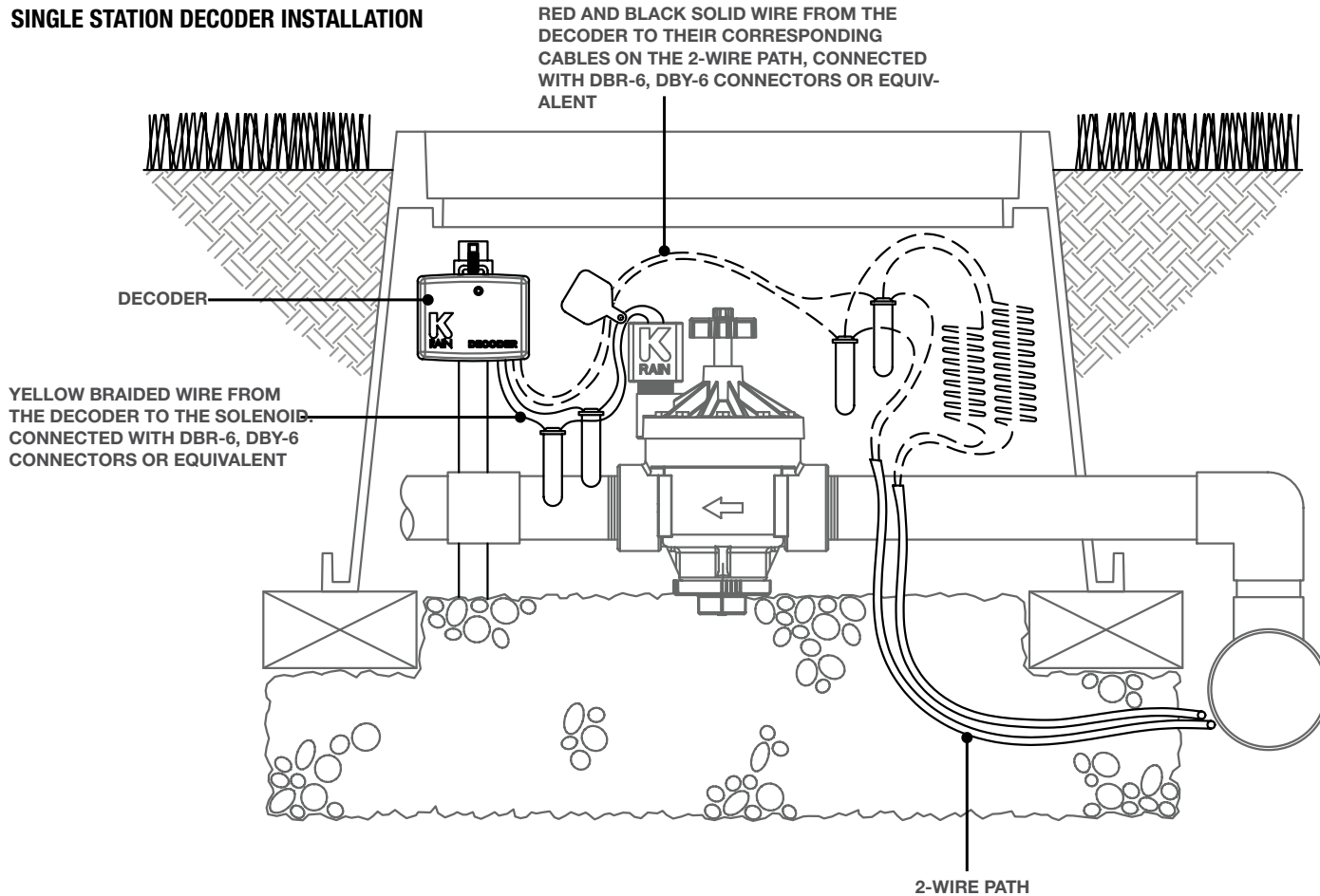

BASIC DECODER INSTALLATION

2-STATION DECODER INSTALLATION

RED AND BLACK SOLID WIRE FROM THE DECODER TO THEIR CORRESPONDING CABLES ON THE 2-WIRE PATH, CONNECTED WITH DBR-6, DBY-6 CONNECTORS OR EQUIVALENT

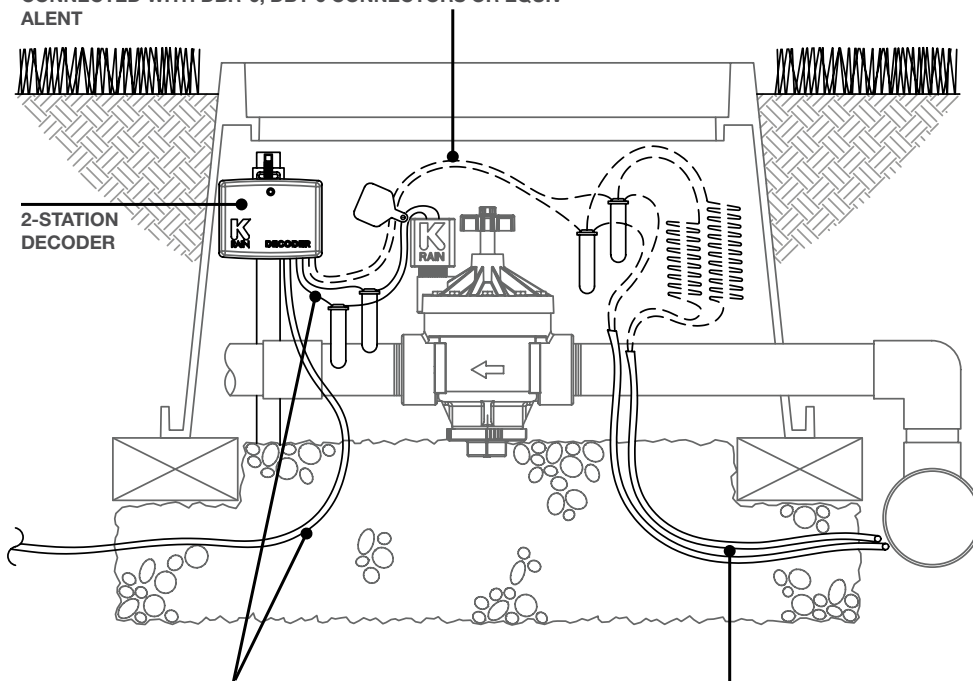

2-STATION DECODER

YELLOW BRAIDED WIRE FROM THE DECODER TO THE SOLENOID. CONNECTED WITH DBR-6, DBY-6 CONNECTORS OR EQUIVALENT

2-WIRE PATH

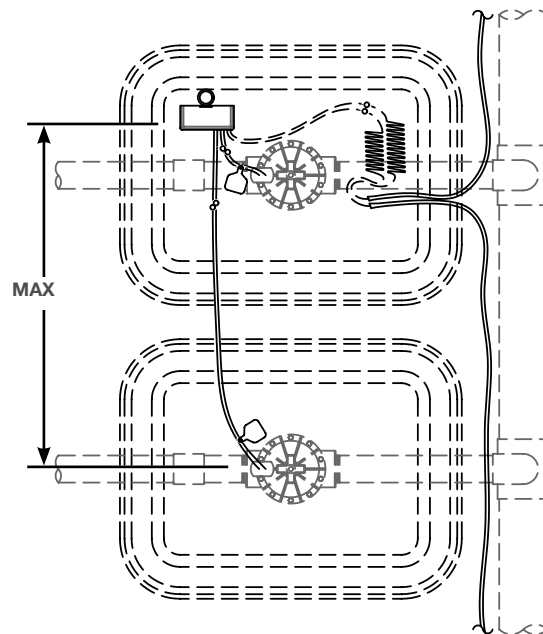

MAX

IF THE VALVES BEING CONNECTED ARE IN SEPARATE VALVE BOXES, THE MAXIMUM DISTANCE FROM THE DECODER SHOULD BE NO MORE THAN 100'

BASIC DECODER INSTALLATION

4-STATION DECODER INSTALLATION

RED AND BLACK SOLID WIRE FROM THE DECODER TO THEIR CORRESPONDING CABLES ON THE 2-WIRE PATH, CONNECTED WITH DBR-6, DBY-6 CONNECTORS OR EQUIVALENT

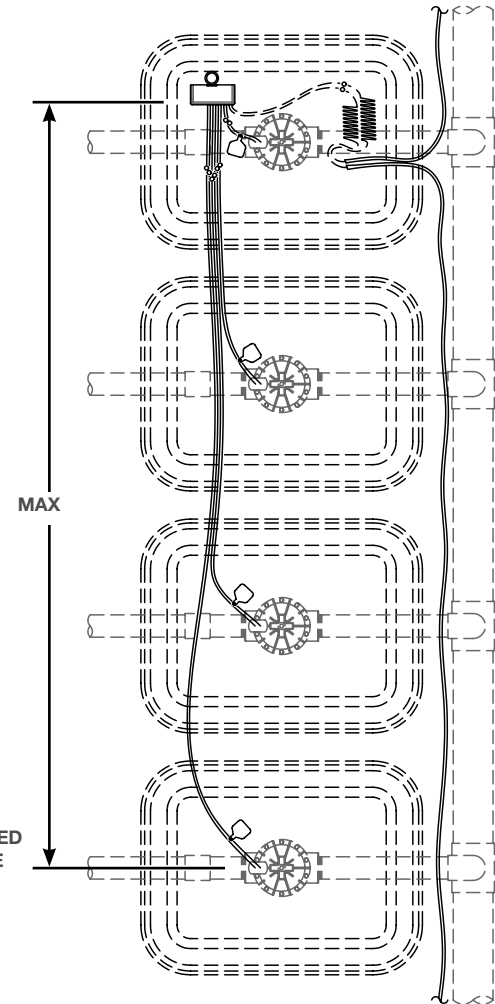
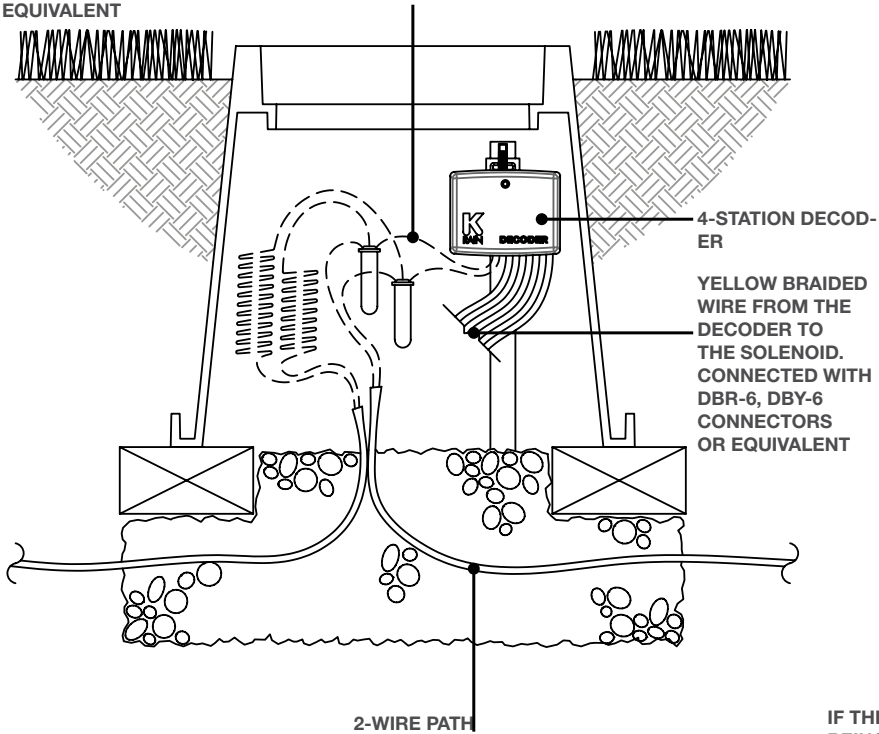

IF THE VALVES BEING CONNECTED ARE IN SEPARATE VALVE BOXES, THE MAXIMUM DISTANCE FROM THE DECODER SHOULD BE NO MORE THAN 100'

BASIC SURGE PROTECTOR INSTALLATION

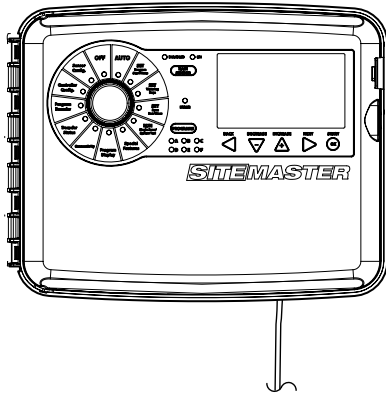

The minimum recommended surge protection is one grounded surge protector at the beginning and end of each wire path and a grounded surge protector every 1,000 ft/300m or every 12 decoders, whichever comes first. This is the minimum amount. For greater protection the system can be grounded more frequently. There is no max limit of surge protectors.

The system should be grounded with rods and plates with no more than 10 Ohms resistance (Grounding electrodes must meet at least minimum US National Electrical Code (NEC)).

This should be measured using a fall-of-potential meter, not a clamp meter. It is recommended that the ground resistance is checked on a regular basis to ensure proper system protection.

It is important to replace these surge protectors if the system has been damaged.

RED AND BLACK SOLID WIRE FROM THE DECODER TO THEIR CORRESPONDING CABLES ON THE 2-WIRE PATH, CONNECTED WITH DBR-6, DBY-6 CONNECTORS OR EQUIVALENT.

ONE SURGE PROTECTOR WILL GO BETWEEN THE CONTROLLER AND THE FIRST ZONE. THE SECOND WILL GO ON THE END OF EACH LINE COMING FROM THE CON-

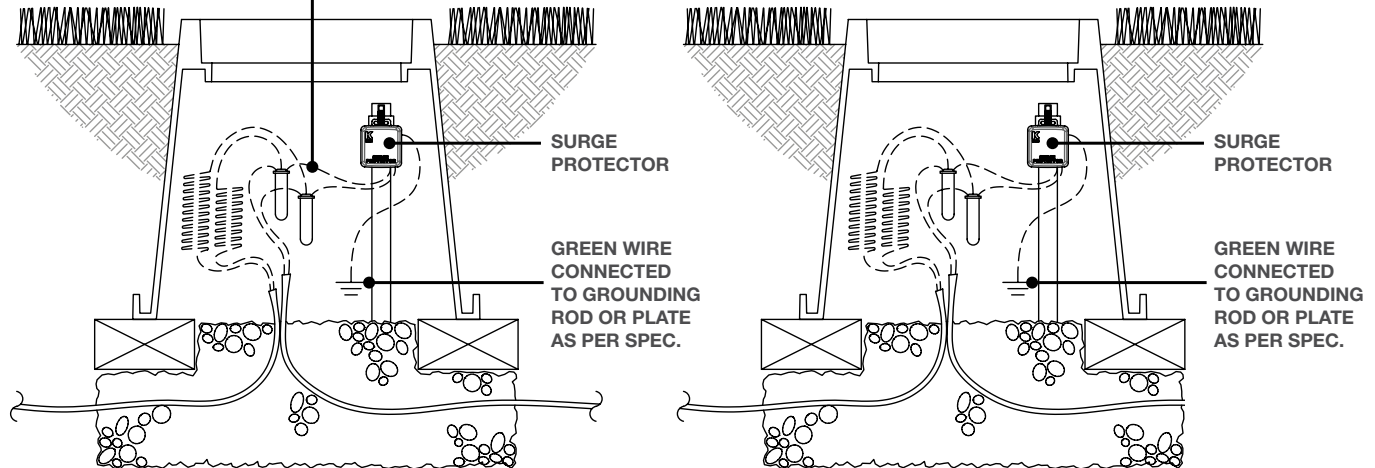

GROUNDING SPECIFICATIONS

CONTROLLER GROUNDING

The controller will be grounded with a Paige 182007 (10ft copper clad rod) or equivalent and a Paige 182199IC grounding plate (4" x 96" with 25' continuous 6 AWG) or equivalent. Grounding plate to be installed with two 50lb bags of Power Set Earth Contact Fill.

Grounding rod should be placed 8'-10' from the controller and at a right angle with the two-wire path. The grounding plate should be a minimum of 15' from the grounding rod using the 6 AWG bare copper wire included with the plate. The wire should be kept in as straight a path as permitted, use sweeping turns when necessary.

Use Cadweld "One-Shot" to secure ground plate wire to grounding rod. The grounding plate is to be installed a minimum of 30" below surface and set in two 50lb bags of PowerSet Earth Contact Fill (keep moisture level at 15% or more at all times). (Grounding plate needs to meet NEC section 250 requirements).

Ground resistance should be measured using an earth-to-ground meter, the resistance is to be 10 ohms or less. If you read over 10 ohms, an additional plate should be added (use the same process and specs as the first plate). Surge protectors should be grounded with a

DECODER/SURGE PROTECTOR GROUNDING

ground plate and/or grounding rod (Plate: Paige 182199/182201; Rod: 182000IC10/ 182000IC6). Use any combination to achieve 10ohms or less. If multiple plates or rods are installed, they need to have a minimum of 15' between them. Plate to be installed with minimum 50lb of PowerSet Earth Contact Fill. (Grounding plate needs to meet NEC section 250 requirements). Grounding plate should be installed 30" below the surface and should maintain 15% moisture level.

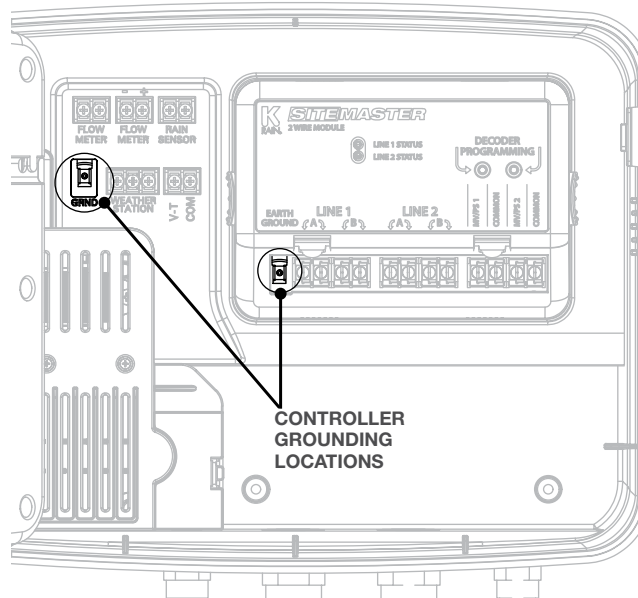

INSTALLATION

The Sitemaster controller can be installed either indoors or outdoors and must be installed in compliance with local electrical codes.

For the best viewing and ease of programming we recommend installation at eye level.

The mounting location should have access to 115VAC or 220VAC electrical power and allow enough bottom clearance for the installation of conduit or a “junction” box if required.

Installation should be done at least 15 feet away from a pump start relay or any high draw motors such as air conditioners and refrigerators.

For ease of installation the enclosure door and main panel can be removed. 17 inches of horizontal clearance to the left is necessary to fully open the hinged door.

DOOR REMOVAL

1. Making sure the door is unlocked, open the enclosure door and swing it to the left until fully open.
2. Using both hands, grasp both the top and bottom portions of the door at the hinge location.
3. Gently pull either the top or bottom portion of the door forward until the door releases.

MAIN PANEL REMOVAL

1. Open the front panel by grasping the finger hold on the top right side of the front panel. Swing the panel open to the left.
2. Disconnect the ribbon cable from the rear of the main panel by gently pulling the ribbon connector straight out of the socket.
3. Using both hands, grasp both the top and bottom portions of the main panel at the hinge location.
4. Gently push the main panel upwards until the hinge pin is free of the enclosure socket.

MOUNTING THE CONTROLLER

The SiteMaster has two keyhole slots on the top / back of the controller. Two circular mounting holes are located at the bottom / back of the controller. One of the three mounting holes is located inside the 115VAC or 220VAC connection box.

Use a pencil to mark the eye level position on the mounting wall. Or, use the template provided for easy installation.

Drive an appropriate fastening device for the type of wall material into the mark for the keyhole.

Hang the controller on the keyhole slots making sure the fastener is secured on the narrow neck area of the keyhole slot.

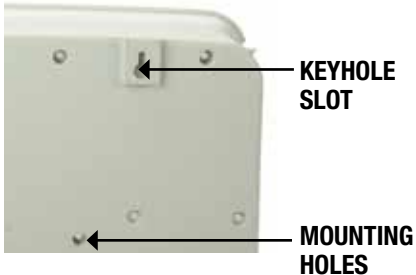

Making sure the controller is level, drive an appropriate fastener(s) in the lower circular hole(s).

The SiteMaster has three “knockout” plugs available for routing valve, pump start and sensor wires. All are located on the bottom of the cabinet and sized for 1”, 1-1/4”, 1-3/8” or 2” PVC male adapters.

In the combination “knockout” plugs, tap a screwdriver in the groove around each in several places to remove the knockout.

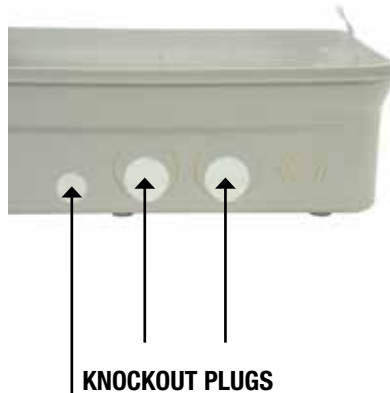

POWERING THE CONTROLLER

It is recommended that a licensed electrician perform the following power installation. All electrical connections and wiring must be made according to local building codes. Make sure all electrical power is turned off before any wire connections are attempted.

For ease of installation the enclosure door and main panel can be removed.

FOR OUTDOOR CONTROLLER ONLY:

The knockout located on bottom left side of the cabinet should be used to bring AC power wires and conduit into the power junction box.

The SiteMaster is powered with either 115VAC or 220VAC which must be noted when ordering the unit.

Connect the AC wires to the transformer wires located inside the power junction box with wire nuts or other locally approved connectors.

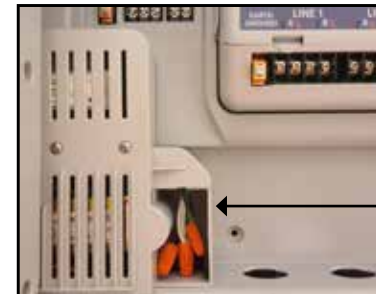

CONTROLLER CONFIGURATION

The CONTROLLER CONFIG. dial position is used to set:

- Controller Date/Time
- Imperial or Metric
- 24 hr./12 hr. Clock
- Assign Individual Program Names
- Current Display (on AUTO screen)
- Display Flow

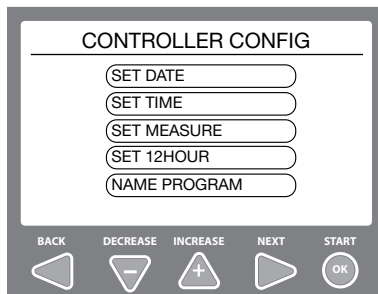
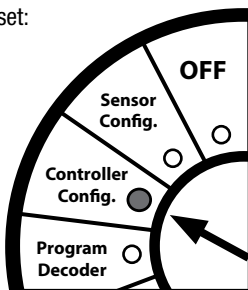

SET DATE

With this feature, you will be setting the actual calendar date used in programming the controller.

1. **SET DATE** will be highlighted, push **OK**.

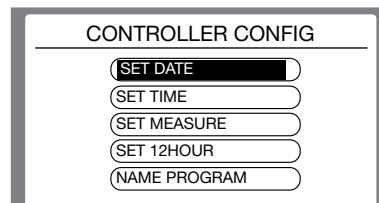

2. The Day selection will be highlighted first. Use the ▼/▲ arrows to set the desired numeric date.

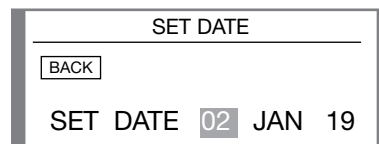

3. Use the ► arrow to cycle to the Month. Using the ▼/▲ arrows cycle up or down until the desired month is shown.

4. Use the ► arrow to cycle to the Day. Using the ▼/▲ arrows cycle up or down until the desired Day is shown.

SET TIME

With this feature, you will be setting the time clock used in programming the controller.

1. Use the ▼/▲ arrows to cycle down to **SET TIME**, push **OK**.

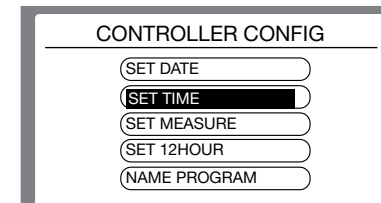

2. The **HOUR** selection will be highlighted. Use the ▼/▲ arrows to set the desired hour. If you cycle past 12, the AM will automatically change to PM.

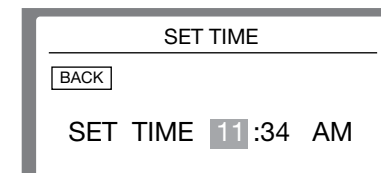

3. Use the ► arrow to cycle to the minute position. Using the ▼/▲ arrows cycle up or down until the desired minute is shown.

CONTROLLER CONFIGURATION

SET IMPERIAL OR METRIC

With this feature, you will be setting how the controller displays numeric values, either Metric or Imperial values can be shown.

1. Use the ▼/▲ arrows to cycle down to **SET MEASURE**, push **OK**.

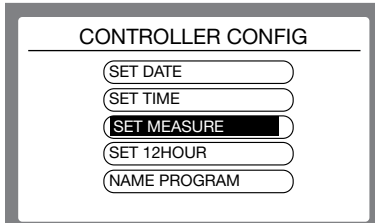

2. Use the ▼/▲ arrows to cycle to the desired selection, push **OK**.

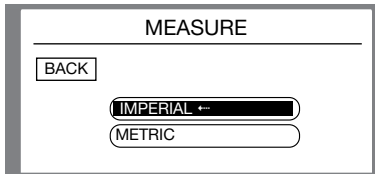

3. Use the ◀ key to move the cursor to highlight the **BACK** button on the screen, then push the ◀ key once more to verify the selection.

SET 12 / 24 HR CLOCK

With this feature, you will be telling the controller to display a 12 hour clock or a 24 hour clock. This will be used for programming purposes as well.

1. Use the ▼/▲ arrows to cycle down to **SET 12 HOUR**, push **OK**.

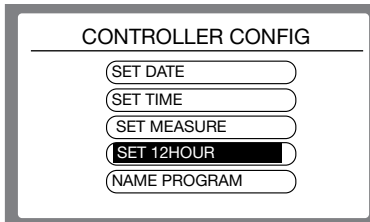

2. Use the ▼/▲ arrows to cycle to the desired selection, push **OK**.

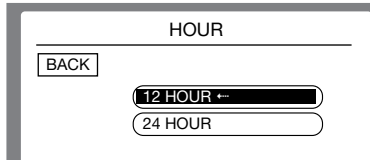

3. Use the ◀ key to move the cursor to highlight the **BACK** button on the screen, then push the ◀ key once more to verify the selection.

NAME PROGRAM

This feature allows you to rename any of the 6 preset program names (A,B,C,D,E, & F) to whatever best suites your needs, using our on screen keyboard.

1. Use the ▼/▲ arrows to cycle down to **NAME PROGRAM**, push **OK**.

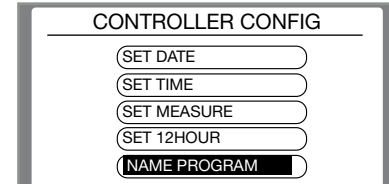

2. Use the ▼/▲ arrows to cycle to the program name you intend to change, push **OK**.

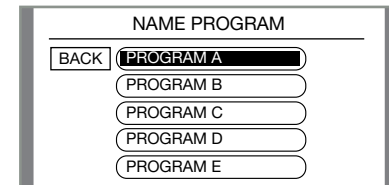

3. Using the ◀▼/▲▶ arrows OR the dial, navigate the cursor around the keyboard to highlight the desired letter or number, then push **OK**. Then scroll the cursor to **NEXT** and push the button to confirm the name change.

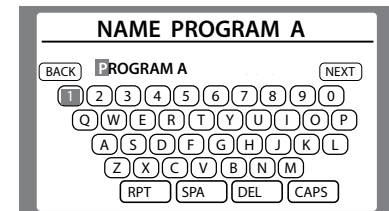

CONTROLLER CONFIGURATION

DISPLAY CURRENT

This feature allows the user to display the active current draw on each line independently on the main display screen.

1. Use the ▼/▲ arrows to cycle down to **DISP CURRENT**, push **OK**.

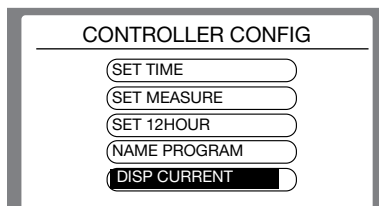

2. Use the ▼/▲ arrows to cycle to the desired selection, push **OK**.

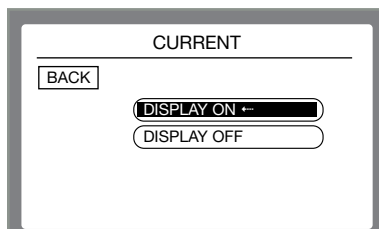

3. Use the ◀ key to move the cursor to highlight the **BACK** button on the screen, then push the ◀ key once more to verify the selection.

This will turn the line display on the AUTO screen.

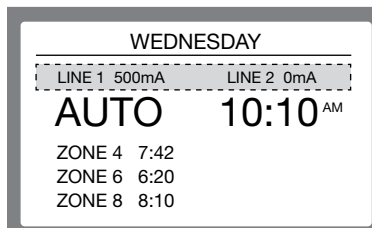

DISPLAY FLOW

This feature allows the user to display the active current flow rate being measured by a connected flow measurement device on the main display screen.

1. Use the ▼/▲ arrows to cycle down to **DISPLAY FLOW**, push **OK**.

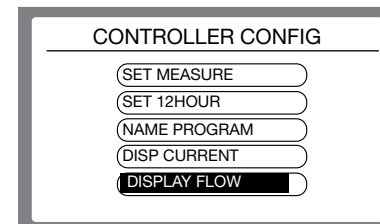

2. Use the ▼/▲ arrows to cycle to the desired selection, push **OK**.

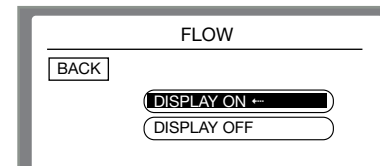

3. Use the ◀ key to move the cursor to highlight the **BACK** button on the screen, then push the ◀ key once more to verify the selection.

PROGRAM A DECODER

TO SYNC A SINGLE STATION DECODER USING THE PROGRAMMING PORT

There are 2 ways to program a decoder to the SiteMaster controller. The first of which would be to use the built in decoder port.

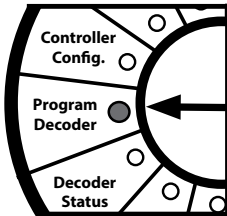

1. Use the ▼/▲ arrows to cycle to **USE DECODER PORT**, push **OK**.

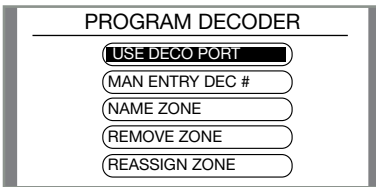

2. Insert the 2 solid decoder wires into the Decoder Programming Port as shown; red wire to the port with the red arrow and the black wire to the port with the black arrow. The wires protective coating must be stripped back to make contact.

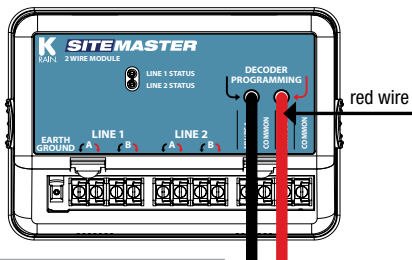

3. Then go back to the midbox face and push **OK** to start. The controller will take a few seconds to read the decoders serial number.

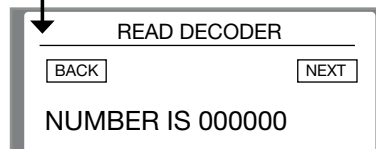
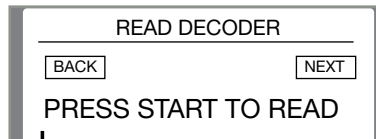

4. The controller should display the decoders serial number. If successful, push the arrow to highlight **NEXT**, then again to continue. If the display shows all zeros, you will need to repeat the process.

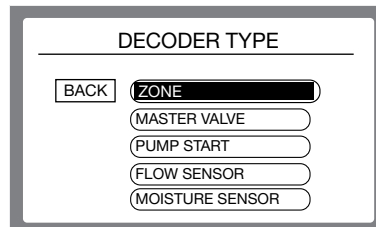

5. The screen will then display as shown above. Use the ▼/▲ arrows to highlight what you are assigning the decoder to be. To set the decoder as a **ZONE**, push **OK**.

6. Use the ◀▶ arrows to move the cursor to the zone you wish to add this decoder to, then push **OK**.

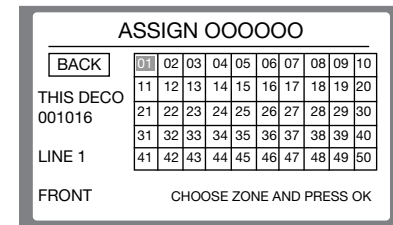

7. The controller is now asking which line you are going to use this decoder on. Use the ▼/▲ arrows to move the cursor to the desired line, then push **OK**.

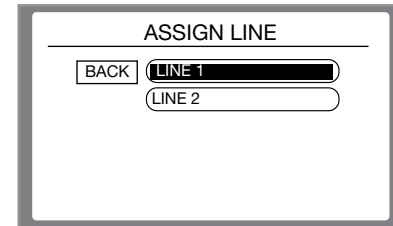

PROGRAM A DECODER

TO SYNC A SINGLE STATION DECODER USING MANUAL ENTRY

There are 2 ways to program a decoder to the SiteMaster controller. This method is using the manual entry feature found on the main control panel.

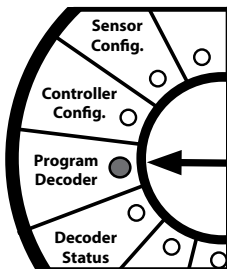

1. Use the ▼/▲ arrows to cycle to **MAN ENTRY DEC #**, push **OK**.

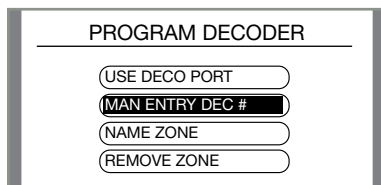

NOTE: the serial number is located on the sticker mounted to the decoder.
2. Use the ◀▶ arrows, OR the Dial, to move the cursor across the numbers on the screen. Once the cursor is on the desired number, push **OK**. Perform this task until the entire serial number is entered.

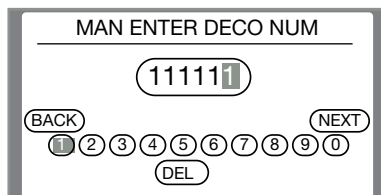

3. Once complete, using the ◀▶ arrows scroll the cursor all the way to the right, then push the ▲ arrow to move it up to the **NEXT** button, then push the ▶ arrow to continue.

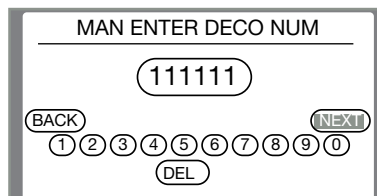

4. The screen will then display as shown below. Use the ▼/▲ arrows to highlight what you are assigning the decoder to be. To set the decoder as a **ZONE**, push **OK**.

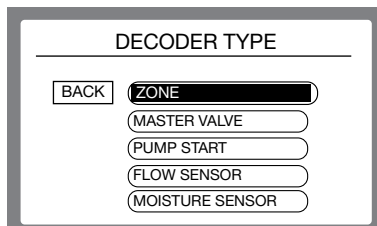

5. Use the ◀▼▲▶ arrows to move the cursor to the zone you wish to add this decoder to, then push **OK**.

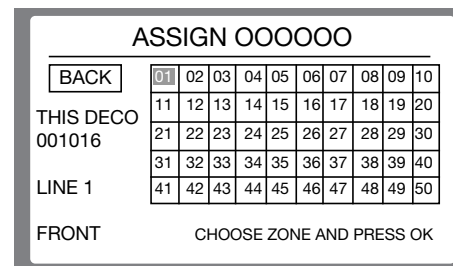

6. The controller is now asking which line you are going to use this decoder on. Use the ▼/▲ arrows to move the cursor to the desired line, then push **OK**.

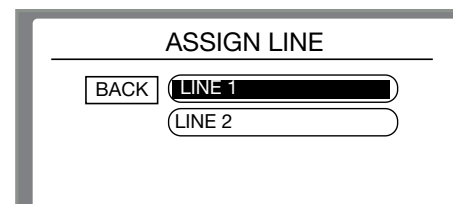

PROGRAM A DECODER

TO SET A SINGLE STATION DECODER AS A MASTER VALVE

With the SiteMaster Controller, you can use up to 3 Single Station Decoders as remote Master Valves or as remote Pump Starts.

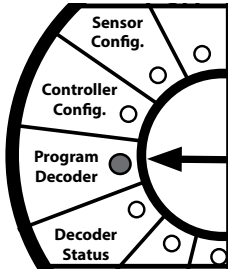

1. To use a decoder as a Master Valve, first use either method shown to sync a Single Station Decoder; either the Programming Port, or the Manual Entry method shown previously. Once you get to the screen where you are being asked what you want to assign this decoder as, use the ▼/▲ arrows to scroll the cursor down to **MASTER VALVE**, then push **OK**.

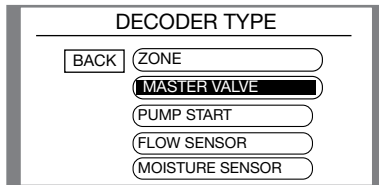

2. From this screen, use the ▼/▲ arrows, move the cursor to the desired Master Valve Location, then push **OK**.

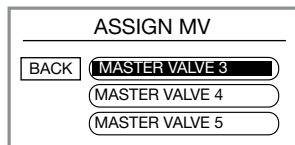

NOTE: See page 37, Reassign a Decoder, for MV/PS zone assignment set up.

3. The controller is now asking which line you are going to use this decoder on. Use the ▼/▲ arrows to move the cursor to the desired line, then push **OK**.

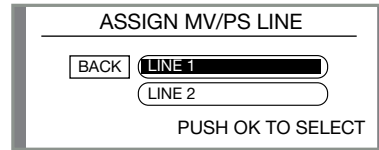

TO SET A SINGLE STATION DECODER AS A PUMP START

1. To use a decoder as a Pump Start, first use either method shown to sync a Single Station Decoder; either the Programming Port, or the Manual Entry method shown previously. Once you get to the screen where you are being asked what you want to assign this decoder as, use the ▼/▲ arrows to scroll the cursor down to **PUMP START**, then push **OK**.

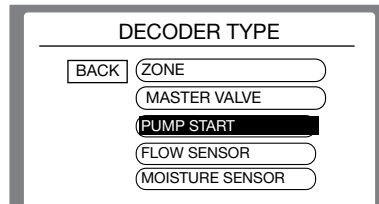

2. From this screen, use the ▼/▲ arrows, move the cursor to the desired Master Valve Location, then push **OK**.

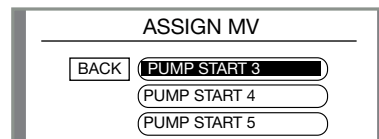

3. The controller is now asking which line you are going to use this decoder on. Use the ▼/▲ arrows to move the cursor to the desired line, then push **OK**. The next screen is a confirmation of the assignment of that PS location, the decoder number, and the line.

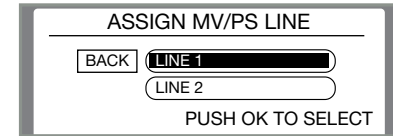

TO SYNC A MULTI STATION DECODER

There are 2 steps to program a multi station decoder to the SiteMaster controller.

NOTE: the serial numbers required are located on the sticker mounted to the decoder.

1. To sync a Multi Station Decoder, first use either method shown to sync a Single Station Decoder; either the Programming Port, or the Manual Entry method shown previously.

This will assign the first available serial number. Once you get to the screen where you are being asked what you want to assign this decoder as, push **OK** to chose **ZONE**.

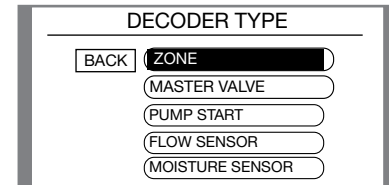

2. To sync the remaining serial numbers and assign them to a zone, you must use the **MANUAL ENTRY PORT** method. See page 20.

PROGRAM A DECODER

NAME ZONE

This feature allows the user to rename any zone to whatever you choose. You are limited to 12 characters. **NOTE:** When you are viewing zones on any other page, the display will show the new name along with the original serial number.

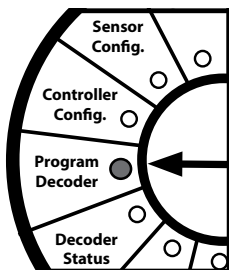

1. Use the ▼/▲ arrows to move the cursor down to **NAME ZONE** and push **OK**.

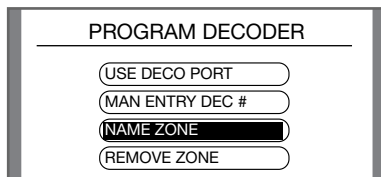

2. Use the ◀▼▲▶ arrows to move the cursor to the zone you wish to rename, then push **OK**.

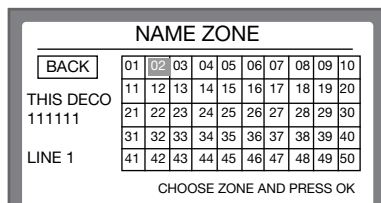

3. Using the arrows ◀▼▲▶ OR the dial, navigate the cursor around the keyboard to highlight the desired letter or number, then push **OK**. Then scroll the cursor to **NEXT** and push the ▶ arrow to confirm the name change.

REMOVE ZONE

This feature allows the user to remove a zone that has been assigned. This will remove the associated decoder with that zone as well.

1. Use the ▼/▲ arrows to move the cursor down to **REMOVE ZONE** and push **OK**.

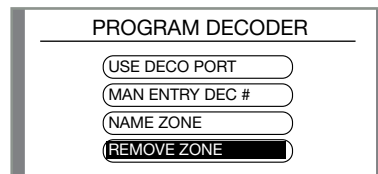

2. Use the ◀▼▲▶ arrows to move the cursor to the zone you wish to remove, then push **OK**.

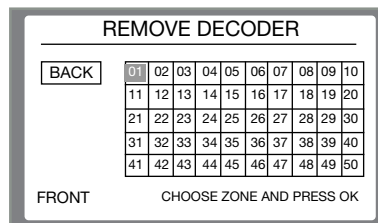

3. The controller will now ask if you are sure you want to remove the chosen zone. To complete this task, use the ▼/▲ arrows to change **NO** to **YES**, and push **OK**. Once successful, the controller will tell you the zone has been removed.

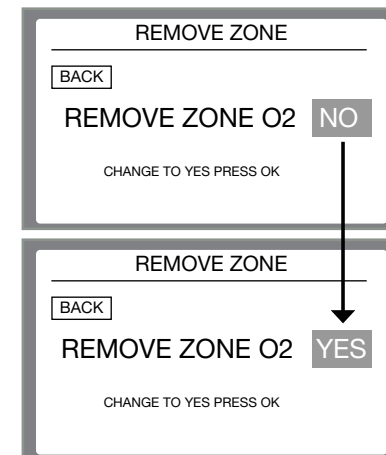

PROGRAM A DECODER

REASSIGN A DECODER

This feature allows the user to reassign a decoder that has been set as a zone to either another zone number, change it to a different 2 wire path, or both.

1. Use the ▼/▲ arrows to move the cursor down to **REASSIGN DECODER** and push **OK**.

PROGRAM DECODER

- USE DECO PORT
- MAN ENTRY DEC #
- NAME ZONE
- REMOVE ZONE
- REASSIGN ZONE**

2. Use the ◀▶ arrows to move the cursor to the zone you wish to rename, then push **OK**.

REASSIGN DECODER

BACK

| | | | | | | | | | |
|----|-----------|----|----|----|----|----|----|----|----|
| 01 | 02 | 03 | 04 | 05 | 06 | 07 | 08 | 09 | 10 |
| 11 | 12 | 13 | 14 | 15 | 16 | 17 | 18 | 19 | 20 |
| 21 | 22 | 23 | 24 | 25 | 26 | 27 | 28 | 29 | 30 |
| 31 | 32 | 33 | 34 | 35 | 36 | 37 | 38 | 39 | 40 |
| 41 | 42 | 43 | 44 | 45 | 46 | 47 | 48 | 49 | 50 |

THIS DECO
111111

LINE 1

CHOOSE ZONE AND PRESS OK

3. The next screen will ask you to confirm the decoders serial number. If this is correct, use the ◀▶ arrows, OR the Dial to move the cursor across the numbers on the screen. Push the ▲ arrow to highlight **NEXT**, then the ▶ arrow to confirm.

PREVIOUS DECO NUM

111111

BACK NEXT

1 2 3 4 5 6 7 8 9 0

DEL

4. Use the ▼/▲ arrows to move the cursor down to **ZONE** and push **OK**.

DECODER TYPE

BACK ZONE

MV / PS

5. Use the ◀▶ arrows to move the cursor to the new zone you wish to reassign this decoder to, then push **OK**.

REASSIGN DECODER

BACK

| | | | | | | | | | |
|----|-----------|----|----|----|----|----|----|----|----|
| 01 | 02 | 03 | 04 | 05 | 06 | 07 | 08 | 09 | 10 |
| 11 | 12 | 13 | 14 | 15 | 16 | 17 | 18 | 19 | 20 |
| 21 | 22 | 23 | 24 | 25 | 26 | 27 | 28 | 29 | 30 |
| 31 | 32 | 33 | 34 | 35 | 36 | 37 | 38 | 39 | 40 |
| 41 | 42 | 43 | 44 | 45 | 46 | 47 | 48 | 49 | 50 |

THIS DECO
111111

LINE 1

CHOOSE ZONE AND PRESS OK

6. Use the ▼/▲ arrows to move the to the new line this decoder will be assigned to and push **OK**.

ASSIGN LINE

BACK LINE 1

LINE 2

7. This feature also allows you to reassign a zone to a MV/PS location. Use the ▼/▲ arrows to move the cursor down to **MV/PS** and push **OK**. Then follow the steps on page 21.

DECODER TYPE

BACK ZONE

MV / PS

PROGRAMMING

OFF

Displays:

1. OFF
2. Current time
3. Day of the week

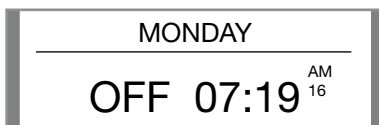
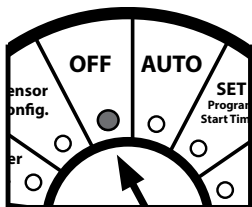

AUTO

Displays:

1. Auto
2. Current Time
3. Day of the week
4. The zone running with a countdown clock for that zone.
5. If more than one zone is running at a time, there is a scrollable list for all the zones that are running.
6. Option to turn on the Line Current display as well as the Flow Display.

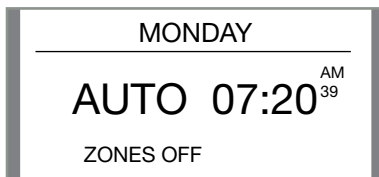
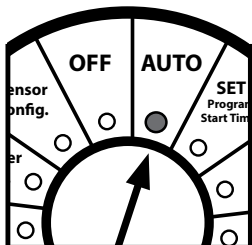

SET PROGRAM START TIMES

Setting Program Start times or watering days is program specific. Use the program button on the front of the midbox to change the program you are in, then set the start times and watering days you wish to run in that program.

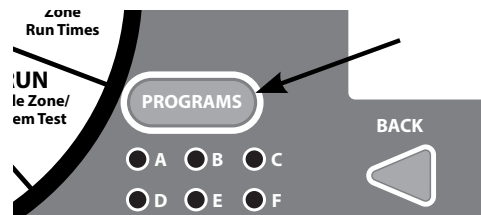
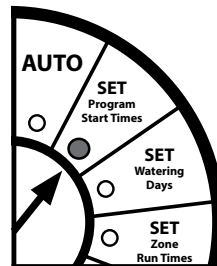

1. When the dial is set to SET Program Start Times, the first start time of the Program you are set to will appear. From the first time you use the ▼/▲ arrows the display will change from **OFF** to having the hour position highlighted.



2. Continue to use ▼/▲ arrows to change the Hour Position to the desired setting.

NOTE: When the hour position is cycled past 12, the **AM** will change to **PM**.

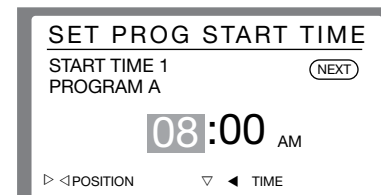

3. When the Hour position is set, use the ► arrow to highlight the minute position. Use the ▼/▲ arrows to set the desired minute setting.

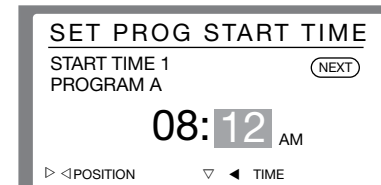

4. Once the minute time is set, the user can either go on to the next start time or change the dial position to finish. To go on to the next start time, use the ▲ arrow to highlight **NEXT**, then push the ► arrow to advance to the next start time. From here you will enter Start Time 2 with the same process. **NOTE:** There are 6 available start times per program. To remove a start time, use the ▼/▲ arrows to change the time to 12:00 am, then ◀ arrow one more time to change it to **OFF**.

PROGRAMMING

SET WATERING DAYS

Setting Program Start times or watering days is program specific. Use the program button on the front of the midbox to change program you are in, then set the start times and watering days you wish to run in that program.

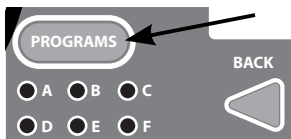
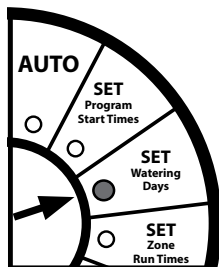

IMPORTANT NOTE: To change the active selected watering day feature you must make a modification within that desired feature. To confirm your selection, the check mark will be showing on the list as well as it will read “in use” at the top of selected page.

SET WEEKDAYS

This feature allows you to set your program to run on specific days of the week.

1. When the dial is set to SET WATERING DAYS, the first selection will be **SET WEEKDAYS**, to use this option, push **OK**.



2. From this screen, use the ◀ ▶ arrows to cycle up and down through the days of the week. To change a day from **OFF** to **ON**, use the ▼/▲ arrows.

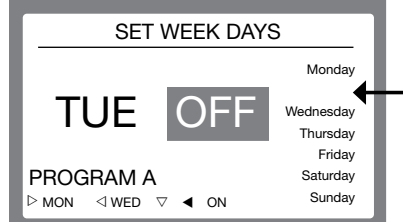
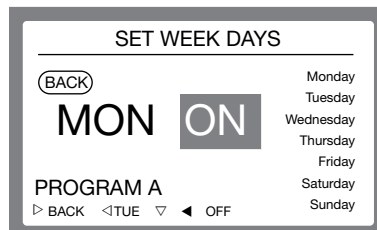

NOTE: The row along the right side shows the days of the week that are set to ON. When the day is missing (like Tuesday in this example) that day is set to OFF.

SET ODD DAYS

This feature allows you to set your program to run on ODD days of the week.

1. Use the arrows ▼/▲ to move the cursor down to **SET ODD DAYS** and push **OK**.

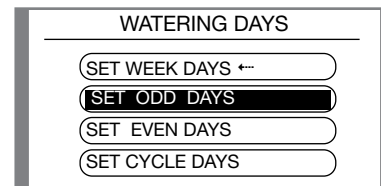

2. Use the ▼/▲ arrows to change the default **OFF** to **ON**.

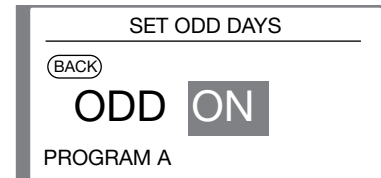

3. Use the ◀ arrow to highlight the back button, then again to go back to the list where you will see a check mark next to **SET ODD DAYS**, meaning this is now the selected setting.

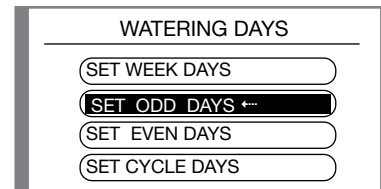

PROGRAMMING

SET EVEN DAYS

This feature allows you to set your program to run on EVEN days of the week.

1. Use the arrows ▼/▲ to move the cursor down to **SET EVEN DAYS** and push **OK**.

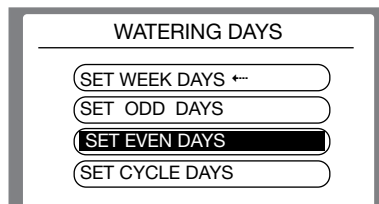

2. Use the ▼/▲ arrows to change the default **OFF** to **ON**.

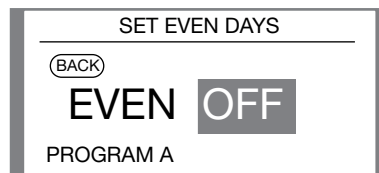

3. Use the ◀ arrow to highlight the back button, then again to go back to the list where you will see a check mark next to **SET EVEN DAYS**, meaning this is now the selected setting.

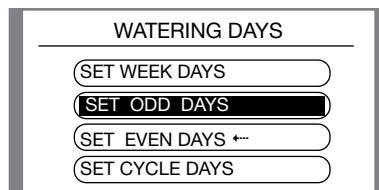

SET CYCLE DAYS

This feature allows you to set your program to cycle on a given number of days apart.

1. Use the ▼/▲ arrows to move the cursor down to **SET CYCLE DAYS** and push **OK**.

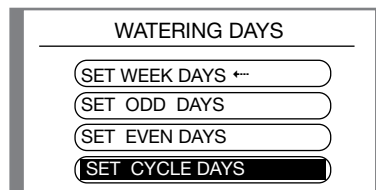

2. From this screen, the **CYCLE DAYS** will be highlighted. This number represents how many days apart you want your program to run. Use the ▼/▲ arrows increase or decrease the cycle day number to a desired amount.

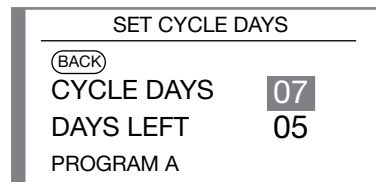

NOTE: The cycle range available under this setting is from 2 days to 31 days.
Example: If the cycle day is set to 4, the system will run that program every fourth day.

3. When Complete, use the arrow to highlight the back button, then again to go back to the list where you will see a check mark next to **SET CYCLE DAYS**, meaning this is now the selected setting.



PROGRAMMING

SET ZONE RUN TIMES

Under this Dial Position, you will be setting the run times associated with each individual zone. The grid that is on the screen will show you:

- What zones you have available.
- What program you are in.
- The name of the zone or serial number of the decoder associated with it.
- Available zones with a triangular symbol in the corner means that zone is available, but currently does not have a run time associated with it.

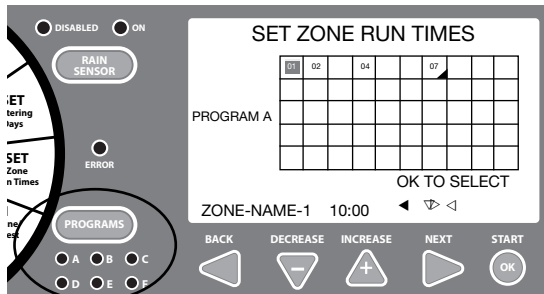
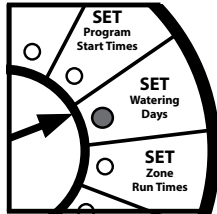

Setting zone run times is Program specific. Use the program button to change the program you are in, then set the zone run time for each zone you wish to run in that particular program. Example: In Program A, Zone 1 is set to run for 10 minutes. That same zone can run for any length of time in other programs, including removing a run time.

- Use the ◀▶▲▶ arrows to move the cursor to highlight the zones run time you wish to modify and push **OK**. The symbol in the corner helps you quickly identify which zones have no run times.

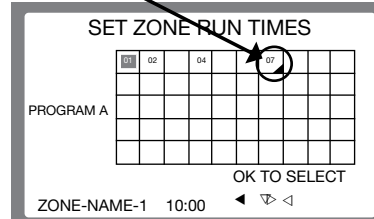

- The default run time for a new zone is 00:00:00. The minute setting will be highlighted first. Use the ▼/▲ arrows to increase or decrease the minutes portion of the run time.

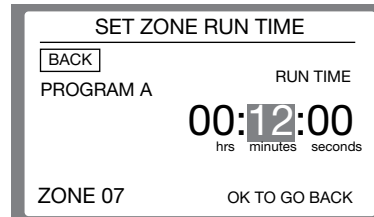

- Use the ◀ arrow to change to the Hour selection, or the ▶ arrow to change to the seconds selection if desired and repeat the setting process.

- When complete, use the ◀ arrow to highlight the BACK button, use the ◀ arrow again to return to the grid to make your next zone selection.



RUN SINGLE ZONE/SYSTEM TEST

RUN SINGLE ZONE TEST

This Feature allows you to run a single zone for a set amount of time. You can use this feature for several trouble shooting scenarios, as well as checking the zone performance. This test will activate the MV or PS associated with that zone if one is used.

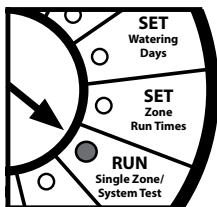

1. When the dial is set to RUN SINGLE ZONE/SYSTEM TEST, the first selection will be **SINGLE TEST**, to use this option, push **OK**.

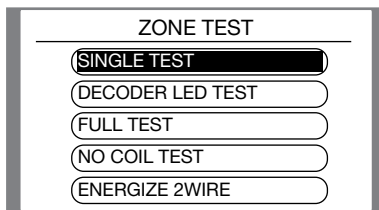

2. Use the ◀▼▲▶ arrows to move the cursor around the grid until you get to the zone you wish to test and push **OK**.

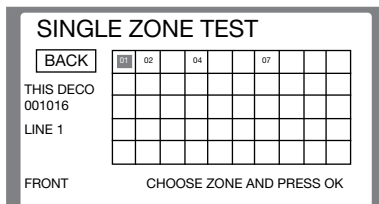

NOTE: The decoders name and serial number for each zone can also be seen on this main screen.

3. Once you selected a zone, this screen will appear. It will show you the zone number along with a run time. The minutes input will be highlighted. Use the ▼/▲ arrows to increase or decrease this run time. Next you can use the ▶ arrow to move the cursor to the seconds input area. Again using the ▼/▲ arrows to increase or decrease time. Once ready to run the zone, push **OK**.

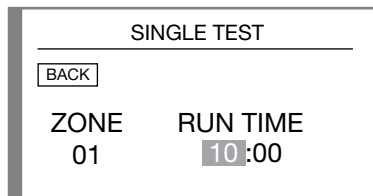

This screen will display while the controller is sending a signal to the selected decoder.

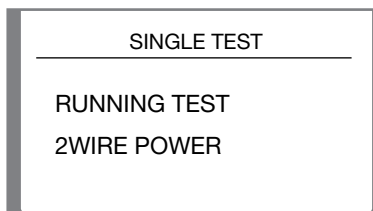

This screen will display while the selected zone is running. Notice it shows the zone name still along with the countdown clock of the time remaining in the test.

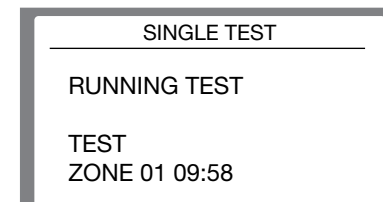

While the test is running, you can either let it finish out the programmed time or push **OK** to end the test at any time.

RUN SINGLE ZONE/SYSTEM TEST

DECODER LED TEST

This screen is used to utilize the LED located on each decoder. When activated, the system will check the overall "health" of each decoder. It will see if it is sending and receiving signals properly. If the Decoder is healthy, it will display a red light in the indicator circle on the face of the decoder.

1. Use the ▼/▲ arrows to scroll down to **DECODER LED TEST** and push **OK**.

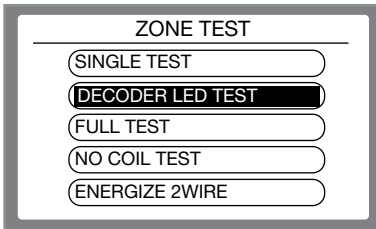

2. Use the ▼/▲ arrows to scroll down to the line you want to activate and push **OK**.

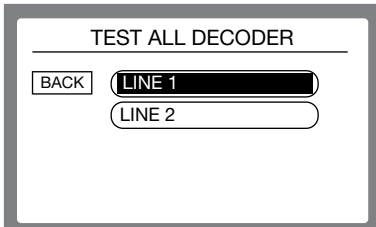

3. Once you selected a line, this screen will appear. It will show you the line number along with a run time. The minutes input will be highlighted. Use the arrows ▼/▲ to increase or decrease this run time. Once ready to run the zone, push **OK**.

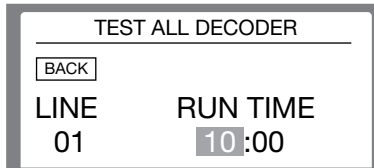

While the test is running, you can either let it finish out the programmed time or push **OK** to end the test at any time.

FULL TEST

This feature allows the user to kick off a test of every zone associated with the controller for a set amount of time.

NOTE: A zone with no run time in any program will not run in this test. It must have a run time in at least 1 program.

1. Use the ▼/▲ arrows to scroll down to **FULL TEST** and push **OK**.

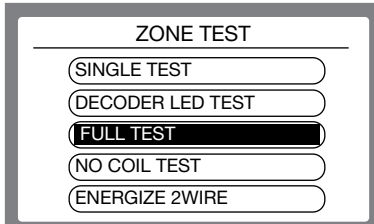

2. The default time for this test is 2 minutes per zone. You can use the default time or change it. The minutes input will be highlighted. Use the ▼/▲ arrows to increase or decrease this run time. Next you can use the ► arrow to move the cursor to the seconds input area. Again using the ▼/▲ arrows to increase or decrease time. Once ready to run the test, push **OK**.

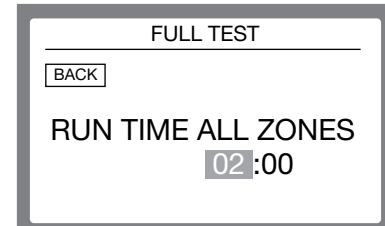

3. While the test is running, you can push **OK** to stop the test, or push the ► arrow to skip to the next available zone.

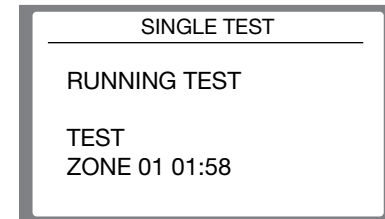

RUN SINGLE ZONE/SYSTEM TEST

NO COIL TEST

No coil test is another diagnostic tool that you can use to narrow down your search when looking for issues with your system. This test sends a signal to each decoder for a set amount of time to simply see if there is resistance found on the solenoid side of the decoder.

1. Use the ▼/▲ arrows to scroll down to **NO COIL TEST** and push **OK**.

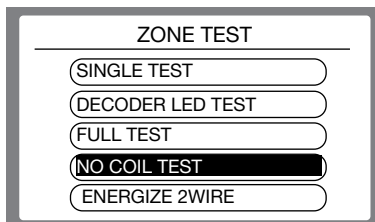

2. This is where you set the amount of time each decoder will be activate for. Default is 20 seconds. Use the ▼/▲ arrows to change the minutes position.

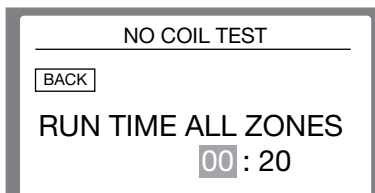

3. Then use the arrow to change the cursor to the seconds position, and again use the arrows to change the time. Once the desired time is set push **OK**.

The system will then run each decoder. It will show you faults directly on this screen, as shown below.

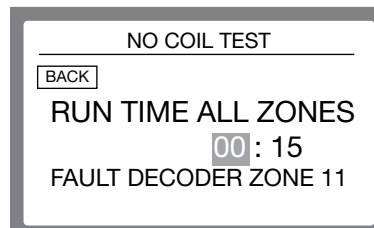
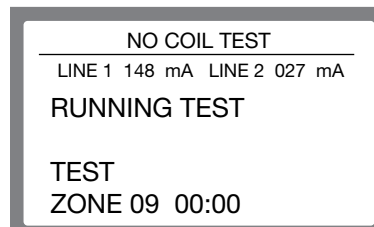

For additional information, faults will also appear on the fault log. For directions on how to use the Fault Log go to page 46.

| POS | LN | TYPE | TIME | DATE | SERVICE |
|------|----|--------|--------|----------|---------|
| ZN11 | 1 | NOCOIL | 10:14A | 14/11/19 | 00:20 |

NOTE: You may see current indicated on a line that does not have a valve running. This is because each decoder creates a small load. Numbers shown above are representational.

ENERGIZE 2-WIRE

This Feature is another diagnostic tool for testing the conductivity of the 2 wire path. This feature will energize the 2 wire path without sending activation signal to decoders. By using a voltage meter, the voltage should be able to be read at any location along the 2 wire path.

1. Use the ▼/▲ arrows to scroll down to **ENERGIZE 2WIRE** and push **OK**.

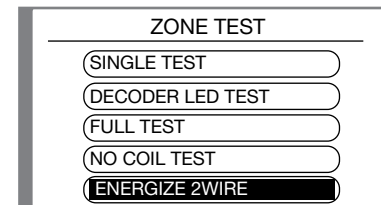

2. Use the ▼/▲ arrows to scroll down to the line you need to energize and push **OK**. You can choose line 1, line 2, or both at the same time.

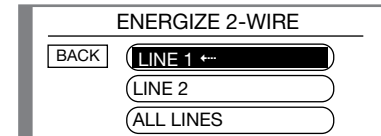

3. Use the ▼/▲ arrows to verify this command by changing the highlighted **OFF** to **ON** and push **OK**. This will energize the path selected. **NOTE:** mA current will be displayed on this screen.

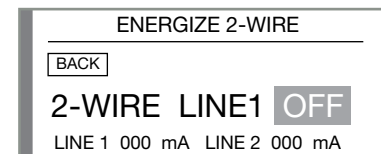

SPECIAL FEATURES

Special Features List:

1. Seasonal Adjust
2. Zone Grouping
3. Delay / Overlap
4. Set MV/PS
5. Clear Programs
6. Save Programs
7. Restore Programs
8. Days Off

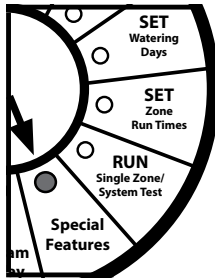

SEASONAL ADJUST

The season adjust feature allows the user to increase or decrease zone run times either by program or set for all without reprogramming each individual station. This feature is used to increase or decrease watering times during seasonal climate changes. The season adjust percentage is calculated on the programmed run time of each zone, for example, if a zone was programmed to run 10 minutes and the seasonal adjust was set to 80%, the zone would only run 8 minutes. Conversely, if it was set to 120%, the zone would run 12 minutes.

1. Use the ▼/▲ arrows to scroll to **SEASONAL ADJUST** and push **OK**.

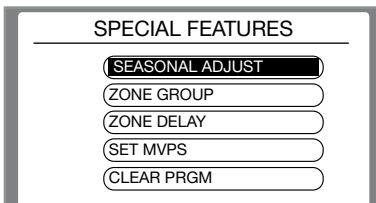

Seasonal adjust can be set either BY PROGRAM or SET FOR ALL.

BY PROGRAM

1. Use the ▼/▲ arrows to scroll to **BY PROGRAM** and push **OK**.

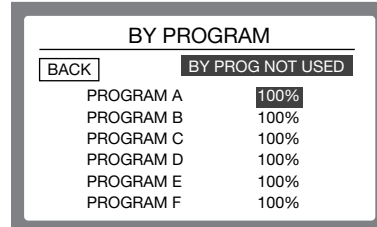
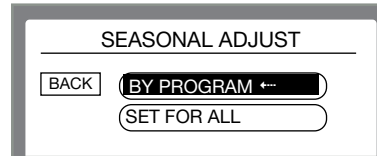

The cursor will start at the first program location. Use the ▼/▲ arrow to modify the percentage. Then use the ◀▶ arrows to scroll down to the next program and repeat the process until all the programs are set to the desired adjustment. Adjustments can be made in 5% increments from 0% to 250%.

SET FOR ALL

1. Use the ▼/▲ arrows to scroll to **SET FOR ALL** and push **OK**.

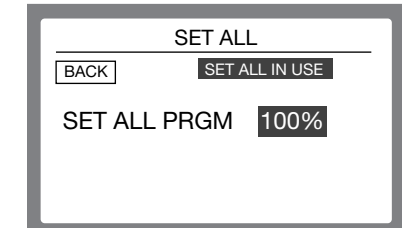

2. The percentage of adjustment will be highlighted. Use the ▼/▲ arrows to adjust this number to the desired total. Adjustments can be made in 5% increments from 0% to 250%.

IMPORTANT NOTE: To activate either of these selections, when the **NOT USED** line is highlighted, push **OK** at any time to change this to read **USED**. You will also note the check mark will be set to your new selection on the previous screen.

SPECIAL FEATURES

ZONE GROUPING

This feature allows you to group individual zones together to make your program run as efficiently as possible. These zones will run together in a given program.

NOTE: The maximum number of zones in a group is 6 zones and 1 MV/PS per primary line (A & B total) line (12 valves and 2 MV/PS total). Also, remember to make sure you have enough available water to run the group you created.

Setting Program Start Times or Watering Days is program specific. Use the program button to change the program you are in, then set the program start times or watering days you wish to run in that particular program.

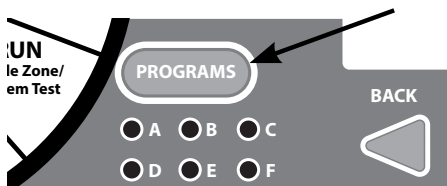

The run times for all the zones in the group you just created are changed to match the run time of the first zone run time in the group. If you want to edit the run time of that group, edit the run time of the first valve.

First use the ▼/▲ arrows to scroll down to **ZONE GROUPING** and push **OK**. From here there are a few options to choose from.

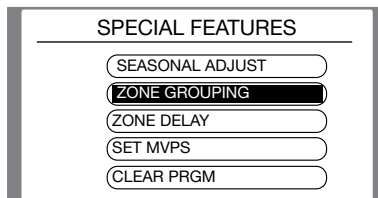

NEW GROUP

1. To create a new group, use the ▼/▲ arrows to scroll to **NEW GROUP** and push **OK**.

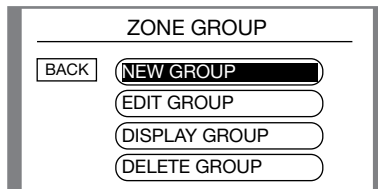

2. When the grid appears, use the ◀▼▲▶ arrows to move the cursor around the grid. When the cursor is on a zone you wish to add to a group, push **OK**. The selected zones will show a bar under their number on the grid. Once all the zones are in the group scroll back to the **BACK** button, then push the ◀ arrow to save this group.

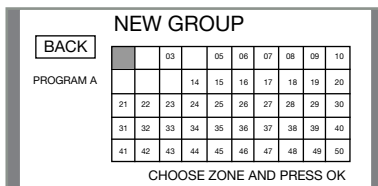

EDIT GROUP

1. To edit an existing group, use the ▼/▲ arrows to scroll to **EDIT GROUP** and push **OK**.

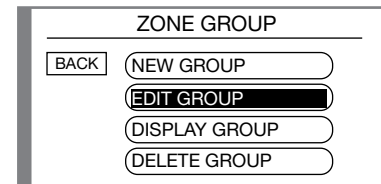

2. Use the arrows to highlight the desired group and push **OK**.

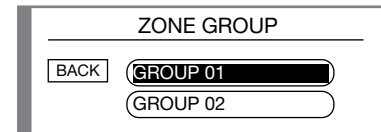

3. When the grid appears, use the ◀▼▲▶ arrows to move the cursor around the grid. When the cursor is on a zone you wish to add or remove from a group, push **OK**. The zones that are in the group will show a bar under their number on the grid. Once editing is complete scroll back to the **BACK** button, then push the ◀ arrow to save this group.

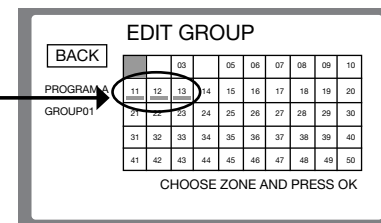

SPECIAL FEATURES

DISPLAY GROUP

Display Group will show you a list of all the groups in a particular program, along with all the zones in that group.

1. Use the ▼/▲ arrows to scroll to **DISPLAY GROUP** and push **OK**.

ZONE GROUP

BACK NEW GROUP EDIT GROUP **DISPLAY GROUP** DELETE GROUP

This screen will display the groups.

GROUP LIST

BACK

| | ZONES |
|----------|----------|
| GROUP 01 | 11 12 13 |
| GROUP 02 | 01 02 04 |

DELETE GROUP

Delete Group allows you to delete a group.

1. Use the ▼/▲ arrows to scroll to **DELETE GROUP** and push **OK**.

ZONE GROUP

BACK NEW GROUP EDIT GROUP DISPLAY GROUP **DELETE GROUP**

2. Use the ▼/▲ arrows to scroll to group you wish to delete and push **OK**.

GROUP DELETE

BACK **GROUP 01** GROUP 02

3. You will now be asked to confirm your selection. The word **NO** will be highlighted. Use the ▼/▲ arrows to change this to **YES** and push **OK** to delete this group.

DELETE GROUP

BACK

DELETE GROUP **NO**

CHANGE TO YES PRESS OK

MAXIMUM DISTANCE GRAPHS

The maximum distance a group of zones can be from the controller. See individual charts on the following pages for more detailed distance guides.

MAXIMUM DISTANCE GRAPH - 12 AWG

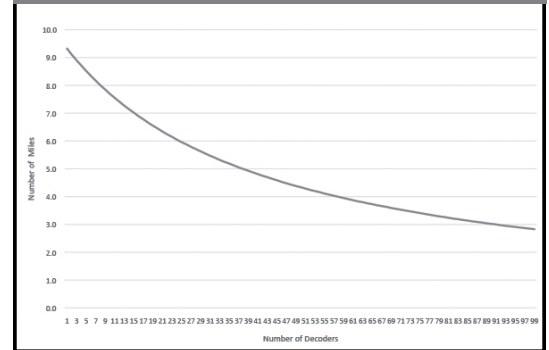

MAXIMUM DISTANCE GRAPH - 14 AWG

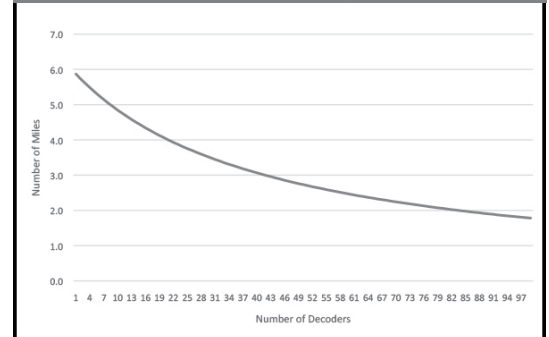

SPECIAL FEATURES

MAXIMUM DISTANCE CHART - 12 AWG

| DECODER QTY | LENGTH | | | |
|-------------|--------|--------|------|--------|
| | MILES | FEET | KM | METERS |
| 1 | 9.3 | 49,210 | 15.0 | 14999 |
| 2 | 9.1 | 48,048 | 14.6 | 14645 |
| 3 | 8.9 | 46,992 | 14.3 | 14323 |
| 4 | 8.7 | 45,989 | 14.0 | 14017 |
| 5 | 8.5 | 44,986 | 13.7 | 13712 |
| 6 | 8.3 | 44,035 | 13.4 | 13422 |
| 7 | 8.2 | 43,138 | 13.1 | 13148 |
| 8 | 8.0 | 42,240 | 12.9 | 12875 |
| 9 | 7.9 | 41,448 | 12.6 | 12633 |
| 10 | 7.7 | 40,603 | 12.4 | 12376 |
| 11 | 7.6 | 39,864 | 12.2 | 12151 |
| 12 | 7.4 | 39,125 | 11.9 | 11925 |
| 13 | 7.3 | 38,386 | 11.7 | 11700 |
| 14 | 7.1 | 37,699 | 11.5 | 11491 |
| 15 | 7.0 | 37,066 | 11.3 | 11298 |
| 16 | 6.9 | 36,379 | 11.1 | 11088 |
| 17 | 6.8 | 35,798 | 10.9 | 10911 |
| 18 | 6.7 | 35,165 | 10.7 | 10718 |
| 19 | 6.6 | 34,584 | 10.5 | 10541 |
| 20 | 6.5 | 34,056 | 10.4 | 10380 |
| 21 | 6.3 | 33,475 | 10.2 | 10203 |
| 22 | 6.2 | 32,947 | 10.0 | 10042 |
| 23 | 6.2 | 32,472 | 9.9 | 9897 |
| 24 | 6.1 | 31,944 | 9.7 | 9737 |
| 25 | 6.0 | 31,469 | 9.6 | 9592 |
| 26 | 5.9 | 31,046 | 9.5 | 9463 |
| 27 | 5.8 | 30,571 | 9.3 | 9318 |
| 28 | 5.7 | 30,149 | 9.2 | 9189 |
| 29 | 5.6 | 29,726 | 9.1 | 9061 |
| 30 | 5.6 | 29,304 | 8.9 | 8932 |
| 31 | 5.5 | 28,882 | 8.8 | 8803 |
| 32 | 5.4 | 28,512 | 8.7 | 8690 |
| 33 | 5.3 | 28,090 | 8.6 | 8562 |
| 34 | 5.3 | 27,720 | 8.4 | 8449 |

| DECODER QTY | LENGTH | | | |
|-------------|--------|--------|-----|--------|
| | MILES | FEET | KM | METERS |
| 35 | 5.2 | 27,403 | 8.4 | 8352 |
| 36 | 5.1 | 27,034 | 8.2 | 8240 |
| 37 | 5.1 | 26,664 | 8.1 | 8127 |
| 38 | 5.0 | 26,347 | 8.0 | 8031 |
| 39 | 4.9 | 26,030 | 7.9 | 7934 |
| 40 | 4.9 | 25,714 | 7.8 | 7837 |
| 41 | 4.8 | 25,397 | 7.7 | 7741 |
| 42 | 4.8 | 25,080 | 7.6 | 7644 |
| 43 | 4.7 | 24,816 | 7.6 | 7564 |
| 44 | 4.6 | 24,499 | 7.5 | 7467 |
| 45 | 4.6 | 24,235 | 7.4 | 7387 |
| 46 | 4.5 | 23,918 | 7.3 | 7290 |
| 47 | 4.5 | 23,654 | 7.2 | 7210 |
| 48 | 4.4 | 23,390 | 7.1 | 7129 |
| 49 | 4.4 | 23,126 | 7.0 | 7049 |
| 50 | 4.3 | 22,915 | 7.0 | 6985 |
| 51 | 4.3 | 22,651 | 6.9 | 6904 |
| 52 | 4.2 | 22,387 | 6.8 | 6824 |
| 53 | 4.2 | 22,176 | 6.8 | 6759 |
| 54 | 4.2 | 21,965 | 6.7 | 6695 |
| 55 | 4.1 | 21,701 | 6.6 | 6614 |
| 56 | 4.1 | 21,490 | 6.6 | 6550 |
| 57 | 4.0 | 21,278 | 6.5 | 6486 |
| 58 | 4.0 | 21,067 | 6.4 | 6421 |
| 59 | 4.0 | 20,856 | 6.4 | 6357 |
| 60 | 3.9 | 20,645 | 6.3 | 6293 |
| 61 | 3.9 | 20,434 | 6.2 | 6228 |
| 62 | 3.8 | 20,222 | 6.2 | 6164 |
| 63 | 3.8 | 20,064 | 6.1 | 6115 |
| 64 | 3.8 | 19,853 | 6.1 | 6051 |
| 65 | 3.7 | 19,694 | 6.0 | 6003 |
| 66 | 3.7 | 19,483 | 5.9 | 5938 |
| 67 | 3.7 | 19,325 | 5.9 | 5890 |
| 68 | 3.6 | 19,166 | 5.8 | 5842 |

| DECODER QTY | LENGTH | | | |
|-------------|--------|--------|-----|--------|
| | MILES | FEET | KM | METERS |
| 69 | 3.6 | 18,955 | 5.8 | 5778 |
| 70 | 3.6 | 18,797 | 5.7 | 5729 |
| 71 | 3.5 | 18,638 | 5.7 | 5681 |
| 72 | 3.5 | 18,480 | 5.6 | 5633 |
| 73 | 3.5 | 18,322 | 5.6 | 5584 |
| 74 | 3.4 | 18,163 | 5.5 | 5536 |
| 75 | 3.4 | 18,005 | 5.5 | 5488 |
| 76 | 3.4 | 17,846 | 5.4 | 5440 |
| 77 | 3.4 | 17,688 | 5.4 | 5391 |
| 78 | 3.3 | 17,530 | 5.3 | 5343 |
| 79 | 3.3 | 17,371 | 5.3 | 5295 |
| 80 | 3.3 | 17,266 | 5.3 | 5263 |
| 81 | 3.2 | 17,107 | 5.2 | 5214 |
| 82 | 3.2 | 16,949 | 5.2 | 5166 |
| 83 | 3.2 | 16,843 | 5.1 | 5134 |
| 84 | 3.2 | 16,685 | 5.1 | 5086 |
| 85 | 3.1 | 16,579 | 5.1 | 5053 |
| 86 | 3.1 | 16,421 | 5.0 | 5005 |
| 87 | 3.1 | 16,315 | 5.0 | 4973 |
| 88 | 3.1 | 16,210 | 4.9 | 4941 |
| 89 | 3.0 | 16,051 | 4.9 | 4892 |
| 90 | 3.0 | 15,946 | 4.9 | 4860 |
| 91 | 3.0 | 15,840 | 4.8 | 4828 |
| 92 | 3.0 | 15,682 | 4.8 | 4780 |
| 93 | 3.0 | 15,576 | 4.7 | 4748 |
| 94 | 2.9 | 15,470 | 4.7 | 4715 |
| 95 | 2.9 | 15,365 | 4.7 | 4683 |
| 96 | 2.9 | 15,259 | 4.7 | 4651 |
| 97 | 2.9 | 15,154 | 4.6 | 4619 |
| 98 | 2.9 | 15,048 | 4.6 | 4587 |
| 99 | 2.8 | 14,942 | 4.6 | 4554 |

NOTE: These measurements take into consideration the system is fully utilizing all 99 zones and no MV/PS is being used on the 2-wire path. Example: If an entire installation has a total of 50 decoders on one 12 AWG 2 wire path, the length of that path can be up to 4.3 miles (7 km).

SPECIAL FEATURES

MAXIMUM DISTANCE CHART - 14 AWG

| DECODER QTY | LENGTH | | | |
|-------------|--------|--------|-----|--------|
| | MILES | FEET | KM | METERS |
| 1 | 5.9 | 30,994 | 9.4 | 9446.8 |
| 2 | 5.7 | 30,262 | 9.2 | 9223.8 |
| 3 | 5.6 | 29,597 | 9.0 | 9021.1 |
| 4 | 5.5 | 28,965 | 8.8 | 8828.5 |
| 5 | 5.4 | 28,333 | 8.6 | 8635.9 |
| 6 | 5.3 | 27,735 | 8.5 | 8453.5 |
| 7 | 5.1 | 27,169 | 8.3 | 8281.2 |
| 8 | 5.0 | 26,604 | 8.1 | 8108.9 |
| 9 | 4.9 | 26,105 | 8.0 | 7956.8 |
| 10 | 4.8 | 25,573 | 7.8 | 7794.6 |
| 11 | 4.8 | 25,107 | 7.7 | 7652.7 |
| 12 | 4.7 | 24,642 | 7.5 | 7510.8 |
| 13 | 4.6 | 24,176 | 7.4 | 7368.9 |
| 14 | 4.5 | 23,744 | 7.2 | 7237.2 |
| 15 | 4.4 | 23,345 | 7.1 | 7115.5 |
| 16 | 4.3 | 22,913 | 7.0 | 6983.8 |
| 17 | 4.3 | 22,547 | 6.9 | 6872.3 |
| 18 | 4.2 | 22,148 | 6.8 | 6750.6 |
| 19 | 4.1 | 21,782 | 6.6 | 6639.1 |
| 20 | 4.1 | 21,449 | 6.5 | 6537.8 |
| 21 | 4.0 | 21,084 | 6.4 | 6426.3 |
| 22 | 3.9 | 20,751 | 6.3 | 6324.9 |
| 23 | 3.9 | 20,452 | 6.2 | 6233.7 |
| 24 | 3.8 | 20,119 | 6.1 | 6132.3 |
| 25 | 3.8 | 19,820 | 6.0 | 6041.1 |
| 26 | 3.7 | 19,554 | 6.0 | 5960.0 |
| 27 | 3.6 | 19,255 | 5.9 | 5868.8 |
| 28 | 3.6 | 18,989 | 5.8 | 5787.7 |
| 29 | 3.5 | 18,723 | 5.7 | 5706.6 |
| 30 | 3.5 | 18,456 | 5.6 | 5625.5 |
| 31 | 3.4 | 18,190 | 5.5 | 5544.4 |
| 32 | 3.4 | 17,958 | 5.5 | 5473.5 |
| 33 | 3.4 | 17,692 | 5.4 | 5392.4 |
| 34 | 3.3 | 17,459 | 5.3 | 5321.4 |
| 35 | 3.3 | 17,259 | 5.3 | 5260.6 |

| DECODER QTY | LENGTH | | | |
|-------------|--------|--------|-----|--------|
| | MILES | FEET | KM | METERS |
| 36 | 3.2 | 17,027 | 5.2 | 5189.7 |
| 37 | 3.2 | 16,794 | 5.1 | 5118.7 |
| 38 | 3.1 | 16,594 | 5.1 | 5057.9 |
| 39 | 3.1 | 16,395 | 5.0 | 4997.1 |
| 40 | 3.1 | 16,195 | 4.9 | 4936.3 |
| 41 | 3.0 | 15,996 | 4.9 | 4875.5 |
| 42 | 3.0 | 15,796 | 4.8 | 4814.6 |
| 43 | 3.0 | 15,630 | 4.8 | 4764.0 |
| 44 | 2.9 | 15,430 | 4.7 | 4703.1 |
| 45 | 2.9 | 15,264 | 4.7 | 4652.5 |
| 46 | 2.9 | 15,064 | 4.6 | 4591.6 |
| 47 | 2.8 | 14,898 | 4.5 | 4541.0 |
| 48 | 2.8 | 14,732 | 4.5 | 4490.3 |
| 49 | 2.8 | 14,566 | 4.4 | 4439.6 |
| 50 | 2.7 | 14,433 | 4.4 | 4399.1 |
| 51 | 2.7 | 14,266 | 4.3 | 4348.4 |
| 52 | 2.7 | 14,100 | 4.3 | 4297.7 |
| 53 | 2.6 | 13,967 | 4.3 | 4257.2 |
| 54 | 2.6 | 13,834 | 4.2 | 4216.6 |
| 55 | 2.6 | 13,668 | 4.2 | 4165.9 |
| 56 | 2.6 | 13,535 | 4.1 | 4125.4 |
| 57 | 2.5 | 13,402 | 4.1 | 4084.8 |
| 58 | 2.5 | 13,269 | 4.0 | 4044.3 |
| 59 | 2.5 | 13,136 | 4.0 | 4003.8 |
| 60 | 2.5 | 13,003 | 4.0 | 3963.2 |
| 61 | 2.4 | 12,870 | 3.9 | 3922.7 |
| 62 | 2.4 | 12,737 | 3.9 | 3882.1 |
| 63 | 2.4 | 12,637 | 3.9 | 3851.7 |
| 64 | 2.4 | 12,504 | 3.8 | 3811.2 |
| 65 | 2.3 | 12,404 | 3.8 | 3780.8 |
| 66 | 2.3 | 12,271 | 3.7 | 3740.2 |
| 67 | 2.3 | 12,171 | 3.7 | 3709.8 |
| 68 | 2.3 | 12,072 | 3.7 | 3679.4 |
| 69 | 2.3 | 11,939 | 3.6 | 3638.9 |
| 70 | 2.2 | 11,839 | 3.6 | 3608.4 |

| DECODER QTY | LENGTH | | | |
|-------------|--------|--------|-----|--------|
| | MILES | FEET | KM | METERS |
| 71 | 2.2 | 11,739 | 3.6 | 3578.0 |
| 72 | 2.2 | 11,639 | 3.5 | 3547.6 |
| 73 | 2.2 | 11,539 | 3.5 | 3517.2 |
| 74 | 2.2 | 11,440 | 3.5 | 3486.8 |
| 75 | 2.1 | 11,340 | 3.5 | 3456.4 |
| 76 | 2.1 | 11,240 | 3.4 | 3426.0 |
| 77 | 2.1 | 11,140 | 3.4 | 3395.6 |
| 78 | 2.1 | 11,041 | 3.4 | 3365.2 |
| 79 | 2.1 | 10,941 | 3.3 | 3334.8 |
| 80 | 2.1 | 10,874 | 3.3 | 3314.5 |
| 81 | 2.0 | 10,775 | 3.3 | 3284.1 |
| 82 | 2.0 | 10,675 | 3.3 | 3253.7 |
| 83 | 2.0 | 10,608 | 3.2 | 3233.4 |
| 84 | 2.0 | 10,509 | 3.2 | 3203.0 |
| 85 | 2.0 | 10,442 | 3.2 | 3182.7 |
| 86 | 2.0 | 10,342 | 3.2 | 3152.3 |
| 87 | 1.9 | 10,276 | 3.1 | 3132.0 |
| 88 | 1.9 | 10,209 | 3.1 | 3111.8 |
| 89 | 1.9 | 10,110 | 3.1 | 3081.4 |
| 90 | 1.9 | 10,043 | 3.1 | 3061.1 |
| 91 | 1.9 | 9,976 | 3.0 | 3040.8 |
| 92 | 1.9 | 9,877 | 3.0 | 3010.4 |
| 93 | 1.9 | 9,810 | 3.0 | 2990.1 |
| 94 | 1.8 | 9,744 | 3.0 | 2969.9 |
| 95 | 1.8 | 9,677 | 2.9 | 2949.6 |
| 96 | 1.8 | 9,611 | 2.9 | 2929.3 |
| 97 | 1.8 | 9,544 | 2.9 | 2909.1 |
| 98 | 1.8 | 9,478 | 2.9 | 2888.8 |
| 99 | 1.8 | 9,411 | 2.9 | 2868.5 |

NOTE: These measurements take into consideration the system is fully utilizing all 99 zones and no MV/PS is being used on the 2-wire path. Example: If an entire installation has a total of 50 decoders on one 14 AWG 2 wire path, the length of that path can be up to 2.7 miles (4.4 km).

SPECIAL FEATURES

DELAY/OVERLAP

This feature allow the user to insert a time delay or overlap between the end of any zone's watering cycle and the beginning of the next zone's cycle. Zone Delay will be mainly used for those systems with slow closing valve.

If the number is changed to a positive number (or add time), the system will set a **DELAY**. If a delay of more than 30 seconds is set, the pump start will shut down during the delay to avoid damage to the pump.

If you scroll down below 00:00, the system will set an **OVERLAP**. Overlap time applied to a zone is limited to 10 seconds.

First use the ▼/▲ arrows to scroll down to **ZONE DELAY** and push **OK**. From here there are a few options to choose from.

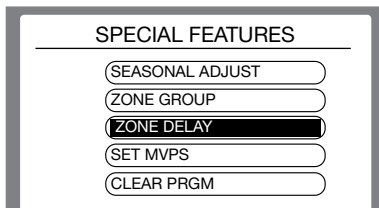

IMPORTANT NOTE: To active either of these selections, when the NOT USED line is highlighted, push **OK** at any time to change this to read USED. You will also note the check mark will be set to your new selection on the previous screen.

BY ZONE

Delay/overlap can be set by individual zone.

1. Use the ▼/▲ arrows to scroll to **BY ZONE** and push **OK**.

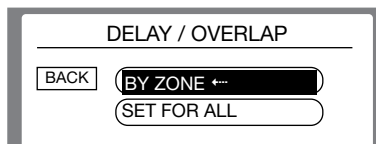

2. The default setting here is all 0:00. Using the ◀ ▶ arrows to cycle from the minute position to the second position, then down to the next zone time, use the ▼/▲ arrows to change the set time.

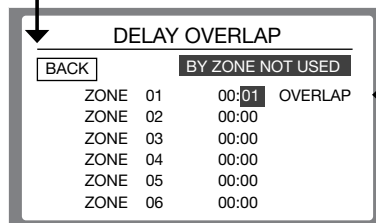
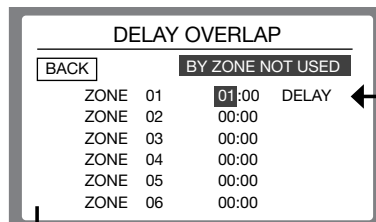

Only the appropriate verbiage shows, it changed depending on which way you scrolled.

SET FOR ALL

The delay/overlap can be set for all, this applies the setting to all available zones.

1. Use the ▼/▲ arrows to scroll to **SET FOR ALL** and push **OK**.

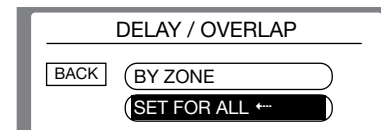

2. The minutes input will be highlighted. Use the ▼/▲ arrows to increase or decrease the time set. Next you can use the ▶ arrow to move the cursor to the seconds input area. Again using the ▼/▲ arrows to increase or decrease time.

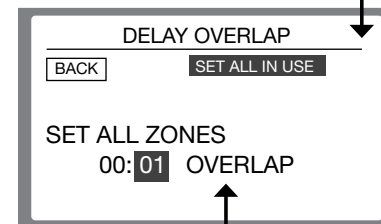
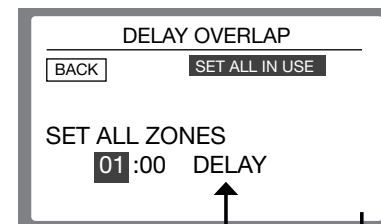

SPECIAL FEATURES

MV/PS - ZONE SETUP

This feature allows the user to quickly change what MV/PS will be used for any particular zone.

1. First use the ▼/▲ arrows to scroll down to **SET MV/PS** and push **OK**.

SPECIAL FEATURES

- SEASONAL ADJUST
- ZONE GROUP
- ZONE DELAY
- SET MVPS**
- CLEAR PRGM

2. Use the ▼/▲ arrows to scroll to **ZONE SET UP** and push **OK**.

SET MVPS

- BACK
- ZONE SET UP**
- PRESSURIZATION

3. Use the ◀▼▲▶ arrows to move the highlighted cursor. All zones will be default to MVPS location 1. If there is a YES in the box, you can highlight it and push **OK** to turn it off. Move to another MVPS location and push **OK** to mark it as YES. This moves the MVPS location associated with that zone.

| | MVPS 1 | MVPS 2 | MVPS 3 | MVPS 4 | MVPS 5 |
|-------|--------|--------|--------|--------|--------|
| ZN 01 | ■ | YES | | | |
| ZN 02 | | | | | |
| ZN 03 | | | YES | | |
| ZN 04 | YES | | | | |
| ZN 05 | YES | | | | |

PUMP PRESSURIZATION

The Pump pressurization setting would be used in a situation where, for example, you had a pump that took extra long to pressurize at the start of the day. Here you can add time so time is not being taken from your zone run times for that delay. It can be set for all 5 individual Pump starts separately and the system will only use this delay at the start of a program. If that same MV/PS is used later in the program, it will not use the delay.

1. First use the ▼/▲ arrows to scroll down to **PRESSURIZATION** and push **OK**.

SET MVPS

- BACK
- ZONE SETUP
- PRESSURIZATION**

2. The default setting here is all 0:00. Using the ◀▶ arrows to cycle from the minute position to the second position, then down to the next zone time, use the ▼/▲ arrows to change the set time. The maximum allowed time is 5 minutes 59 seconds.

| | MVPS 01 | MVPS 02 | MVPS 03 | MVPS 04 | MVPS 05 |
|---------|---------|---------|---------|---------|---------|
| BACK | 00:00 | 00:00 | 00:00 | 00:00 | 00:00 |
| MVPS 01 | 00:00 | | | | |
| MVPS 02 | | 00:00 | | | |
| MVPS 03 | | | 00:00 | | |
| MVPS 04 | | | | 00:00 | |
| MVPS 05 | | | | | 00:00 |

SAVE PROGRAM

This allows the user to save a program. This program can be restored if necessary. Example, if program was changed incorrectly, the original saved program can be restored.

1. Use the ▼/▲ arrows to scroll to **SAVE PROGRAM** and push **OK**.

SPECIAL FEATURES

- ZONE DELAY
- SET MVPS
- CLEAR PRGM
- SAVE PRGM**
- RESTORE PRGM

2. Use the ▼/▲ arrows to change the **NO** to **YES** and push **OK**.

SAVE PROGRAMS

- BACK
- SAVE PROGRAMS **NO**
- CHANGE TO YES PRESS OK

RESTORE PROGRAM

Allows the user to RESTORE a saved program.

1. Use the ▼/▲ arrows to scroll to **RESTORE PROGRAM** and push **OK**.

2. Use the ▼/▲ arrows to change the **NO** to **YES** and push **OK**.

RESTORE PROGRAMS

- BACK
- RESTORE PROG **NO**
- CHANGE TO YES PRESS OK

SPECIAL FEATURES

CLEAR PROGRAM

This allows the user to clear the programs created on the controller. This clears Start Times, Run Times, Groups, and watering days in all 6 programs. This does not remove saved programs or associated decoders stored in the memory.

1. Use the ▼/▲ arrows to scroll to **CLEAR PROGRAM** and push **OK**.

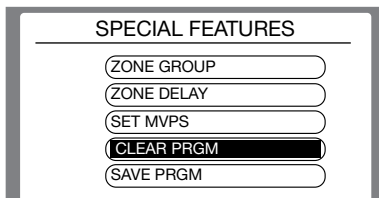

2. Use the ▼/▲ arrows to scroll to **CLEAR PROGRAM** and push **OK**.

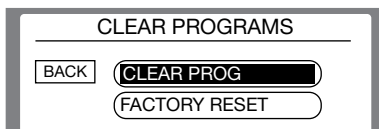

3. Use the ▼/▲ arrows to change the highlighted word **NO** to **YES** and push **OK**.

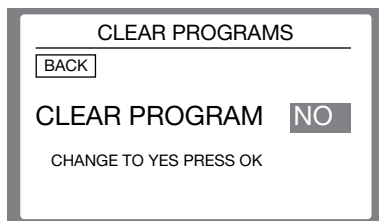

FACTORY RESET

This allows the user to completely clear all program, decoders, or settings of any kind from the controller. This will also remove any saved programs. You CAN NOT restore saved programs if you use FACTORY RESET.

1. Use the ▼/▲ arrows to scroll to **CLEAR PROGRAM** and push **OK**.

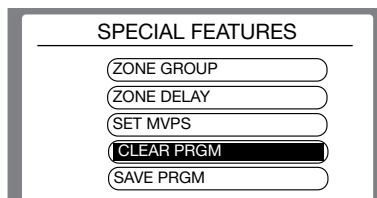

2. Use the ▼/▲ arrows to scroll to **FACTORY RESET** and push **OK**.

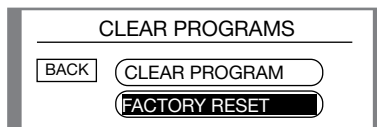

3. Use the ▼/▲ arrows to change the highlighted word **NO** to **YES** and push **OK**.

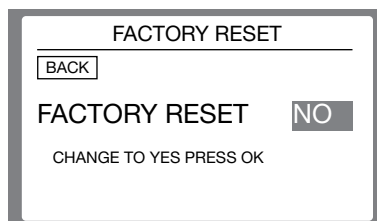

SET DAYS OFF

This feature allows you to permanently stop operation of any program on certain days of the week. This is useful for areas that have day specific watering restrictions.

1. Use the ▼/▲ arrows to scroll to **DAYS OFF** and push **OK**.

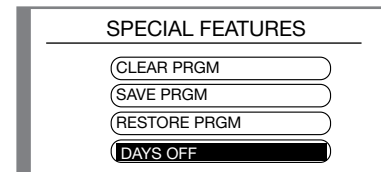

2. From this screen, use the ◀▶ arrows to cycle up and down through the days of the week. To change a day from **OFF** to **ON**, use the ▼/▲ arrows.

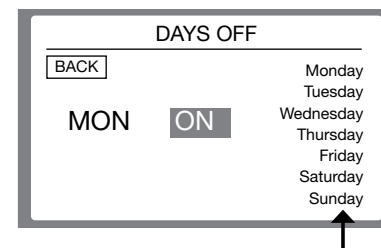

NOTE: The row along the right side shows the days of the week that are set to **ON**. When the day is missing (like Tuesday in this example) that day is set to **OFF**. No program will run on this day, even if it is set to do so.

SENSOR CONFIGURATION

SET FLOW METER

This is where you will assign the type of flow meter and its corresponding number assignment on the controller. Meter 1 and 2 will be the hard wired locations. Meters 3, 4, 5 are decoder driven meters.

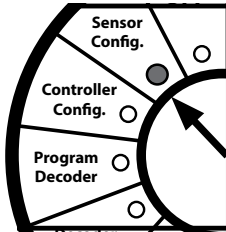

Compatible flow meter information:

KR 735 1" KR 228 3"
 KR 228 1.5" KR 228 4"
 KR 228 2"

1. Use the ▼/▲ arrows to scroll to **FLOW METER TYPE** and push **OK**.

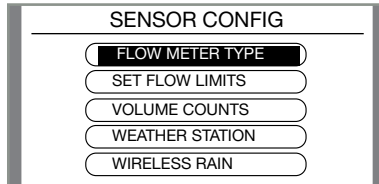

2. The default setting for each position is NOT USED. Use the ▼/▲ arrows to scroll through the available preset Flow Meter options. Use the ◀▶ arrows to scroll to the next meter position.

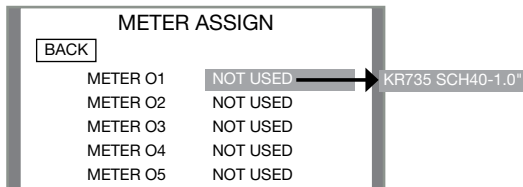

SET FLOW LIMITS

This is where you will set the thresholds you want your system to monitor when dealing with water flow. There are 2 options for this as well. You can set a single universal limit for an entire program or set the limit of each zone individually.

1. Use the ▼/▲ arrows to scroll to **SET FLOW LIMITS** and push **OK**.

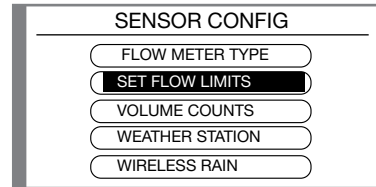

SET PROGRAM LIMITS

1. Use the ▼/▲ arrows to scroll to **PROG LIMITS** and push **OK**.

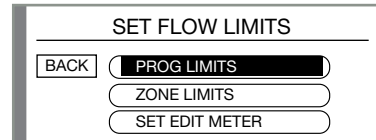

2. Use the ▼/▲ arrows to increase or decrease your desired limits in the highlighted position. Use the ◀▶ arrows to scroll to the next position.

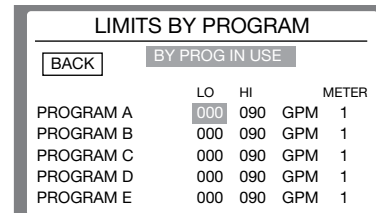

SET ZONE LIMITS

1. Use the ▼/▲ arrows to scroll to **PROG LIMITS** and push **OK**.

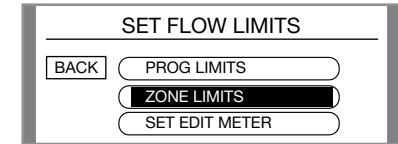

2. Use the ▼/▲ arrows to increase or decrease your desired limits in the highlighted position. Use the ◀▶ arrows to scroll to the next position.

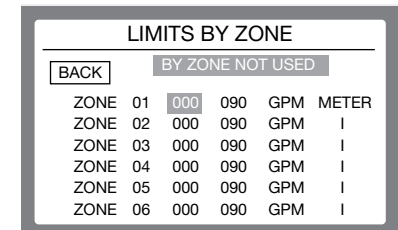

NOTE: The flow limits are set incrementally. The HI limit is set by 10 GPM increments and the LO is set by 1 GPM increments.

IMPORTANT NOTE: To active either of these selections, when the NOT USED line is highlighted, push **OK** at any time to change this to read **USED**. You will also note the check mark will be set to your new selection on the previous screen.

SENSOR CONFIGURATION

SET EDIT METER

This feature allows you to disable the set flow limits established on your controller. This is useful in times like testing your system.

1. Use the ▼/▲ arrows to scroll to **SET FLOW LIMITS** and push **OK**.

SENSOR CONFIG

- FLOW METER TYPE
- SET FLOW LIMITS**
- VOLUME COUNTS
- WEATHER STATION
- WIRELESS RAIN

2. Use the ▼/▲ arrows to scroll to **SET EDIT METER** and push **OK**.

SET FLOW LIMITS

BACK

- PROG LIMITS
- ZONE LIMITS
- SET EDIT METER**

PROGRAM LIMITS IN USE

3. Use the ▼/▲ arrows to scroll to **ENABLED** or **DISABLED** and push **OK**.

SET EDIT METER

BACK

- ENABLED
- DISABLED ←**

VOLUME COUNTS

This feature allows you to see both live flow data as well as accumulative volume counts.

1. Use the ▼/▲ arrows to scroll to **VOLUME COUNTS** and push **OK**.

SENSOR CONFIG

- FLOW METER TYPE
- SET FLOW LIMITS
- VOLUME COUNTS**
- WEATHER STATION
- WIRELESS RAIN

2. Use the ▼/▲ arrows to scroll to **FLOW VOL COUNTS** and push **OK**.

VOLUME COUNT

BACK

- FLOW VOL COUNTS**
- CLR VOL TOTAL
- CLR VOL DAILY

This screen will display, for each meter, the volume (used, the total daily volume, and the live flow information.

FLOW AND VOLUME

BACK

| | | |
|----------|-----------|-----------|
| METER 01 | VOL TOTAL | 0 GAL |
| | VOL DAILY | 0 GAL |
| | FLOW | 000.0 GPM |
| METER 02 | VOL TOTAL | 0 GAL |
| | VOL DAILY | 0 GAL |
| | FLOW | 000.0 GPM |

CLEAR TOTAL VOLUME

This feature allows you to clear or reset the controller's total accumulative volume counts.

1. Use the ▼/▲ arrows to scroll to **CLR VOL TOTAL** and push **OK**.
2. Push **OK** to clear the volume totals.

VOLUME COUNT

BACK

- FLOW VOL COUNTS
- CLR VOL TOTAL**
- CLR VOL DAILY

↓

CLEAR VOL TOTAL

BACK

CLEAR METER 00

CHANGE NUMBER PRESS OK

CLEAR DAILY VOLUME

This feature allows you to clear or reset the controller's total accumulative volume counts.

1. Use the ▼/▲ arrows to scroll to **CLR VOL TOTAL** and push **OK**.
2. Push **OK** to clear the volume totals.

VOLUME COUNT

BACK

- FLOW VOL COUNTS
- CLR VOL TOTAL
- CLR VOL DAILY**

↓

CLEAR VOL DAILY

BACK

CLEAR METER 00

CHANGE NUMBER PRESS OK

SENSOR CONFIGURATION

POSSIBLE FLOW SENSOR ERROR MESSAGES

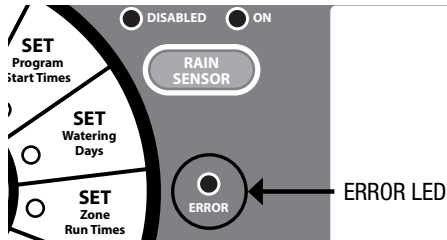

For the following two errors the system will proceed to the next zone.

If there is a High Flow abort, the last zone with that error message will display this:

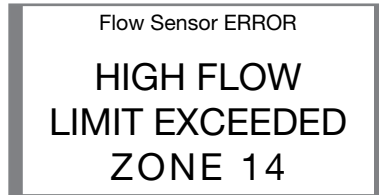

If there is a Low Flow abort, the last zone with that error message will display this:

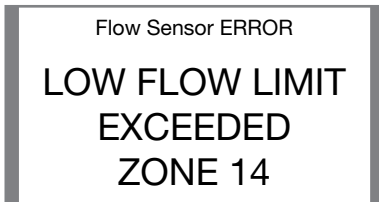

For the following two errors, the system will shut down until the error is cleared.

If water flow is detected when no program is running the display will show:

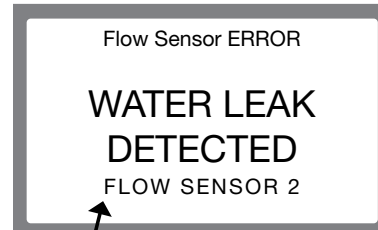

Indicates which flow meter detected the issue.

If no flow is detected while a program is running the display will show:

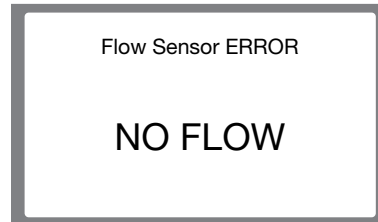

SETTING UP A WEATHER STATION

The SiteMaster controller has hard-wired weather station terminals and connects directly to the 3414 K-Rain Weather Station. The controller will use inputs from these weather stations to calculate ET and modify run times based on a programmable baseline. This modification will be represented by a percentage change, like seasonal adjust. First install the weather station to the provided SiteMaster terminals, then follow the directions below.

1. Use the ▼/▲ arrows to scroll to **WEATHER STATION** and push **OK**. Under this there are multiple options covered here.

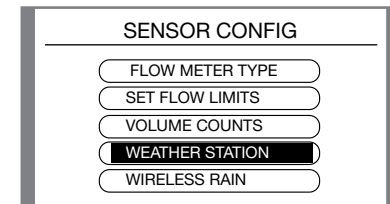

SENSOR CONFIGURATION

WEATHER DATA

This screen displays current weather data.

1. Use the ▼/▲ arrows to scroll to **WEATHER DATA** and push **OK**.

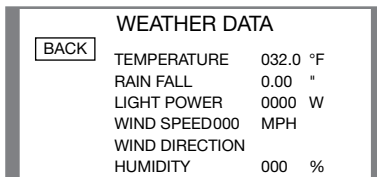
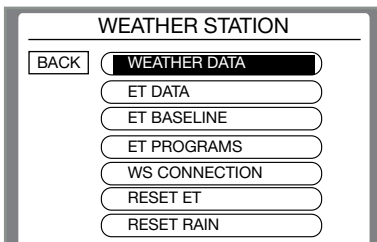

ET DATA

This screen displays all the collected weather data and ET calculations.

1. Use the ▼/▲ arrows to scroll to **ET DATA** and push **OK**.

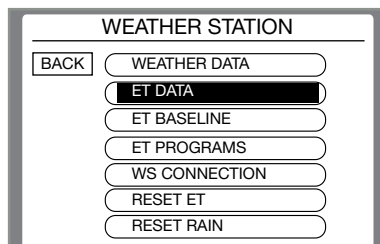

This number represents the % on which the program will run. This example shows 00:00 rain, so the program will run at 100% of its set schedule.

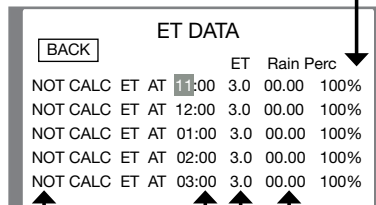

This will say "Calculated ET" once the Weather Station has been set up for 24 hours.

Time of last reading

Total rainfall over previous 24 hrs.

ET calculation (This is a modifiable baseline used in calculating ET. See the ET BASELINE setting below.)

ET BASE LINE

This number represents the amount of water the irrigated surface requires over a given day. The baseline will be used vs the ET calculations to establish how much more or less time the irrigation program will need.

1. Use the ▼/▲ arrows to scroll to **ET BASE LINE** and push **OK**.

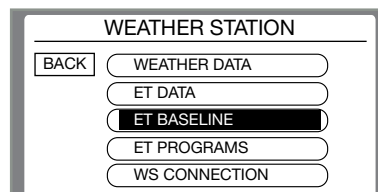

2. Use the ▼/▲ arrows to increase or decrease the base line input total to your desired setting.

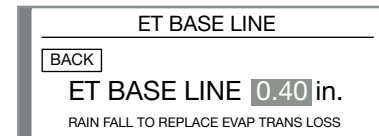

ET PROGRAMS

The controller will also allow the user to use, or not use the weather station input on certain programs. Example: if you want the controller to take the weather station input into account for all programs except Program B, you can set the controller to ignore those inputs and run Program B just as you have set it, regardless of the ET calculations.

1. Use the ▼/▲ arrows to scroll to **ET PROGRAM** and push **OK**.

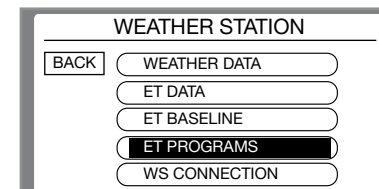

2. Use the ▼/▲ arrows to change the default **NO** to **YES**. Use the ◀ ▶ arrows to scroll down to the next program. YES means the run times will be effected, NO means they will not be effected.

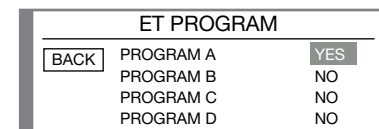

SENSOR CONFIGURATION

WS CONNECTION

This feature allows the user the ability to suspend the Weather Station inputs and go back to your standard irrigation program.

1. Use the ▼/▲ arrows to scroll to **WS CONNECTION** and push **OK**.

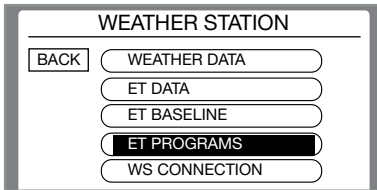

2. Use the ▼/▲ arrows to scroll to the desired setting and push **OK**.

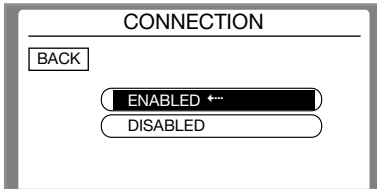

RESET ET

Reset ET resets any of the previous ET calculations in the controller memory. This could be used if a WS is removed from a site, or if the base line needed to be changed.

1. Use the ▼/▲ arrows to scroll to **RESET ET** and push **OK**.

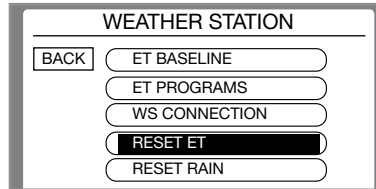

2. Use the ▼/▲ arrows change the highlighted **NO** to **YES** and push **OK**.

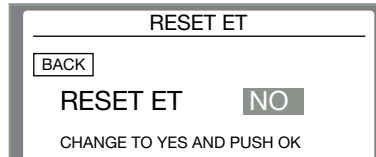

RESET RAIN

Reset rain resets any of the previous rain input data in the controller memory. This could be used if a WS is removed from a site, or if the base line needed to be changed.

1. Use the ▼/▲ arrows to scroll to **RESET RAIN** and push **OK**.

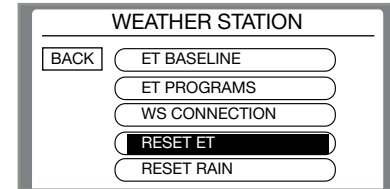

2. Use the ▼/▲ arrows change the highlighted **NO** to **YES** and push **OK**.

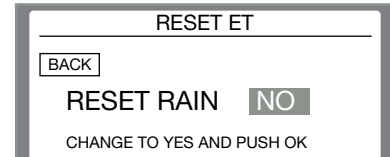

SENSOR CONFIGURATION

CONNECTING A WIRELESS RAIN SENSOR

The SiteMaster Controller is designed to easily sync the K-Rain 3208- WRF-Kit. First install the K-Rain 3206-RF module into its designated space shown here, and secure with screws provided.



3206- RF MOD-

1. Use the ▼/▲ arrows to scroll to **WIRELESS RAIN** and push **OK**. Under this there are multiple options covered here.

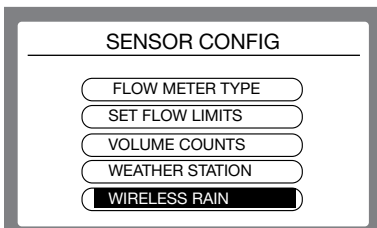

LEARN

2. Use the ▼/▲ arrows to scroll to **LEARN** and push **OK**.

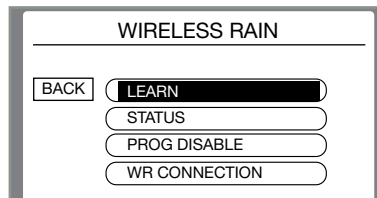

3. For this step have the 3208 Wireless Rain Sensor within reach. At this screen push **OK**, then press the pairing button at the top of the Rain Sensor. The screen will then tell you if this pairing was successful.

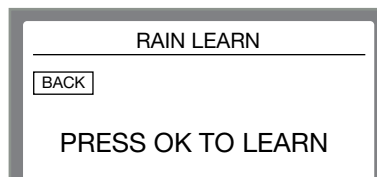

STATUS

Use the ▼/▲ arrows to scroll to **STATUS** and push **OK**.

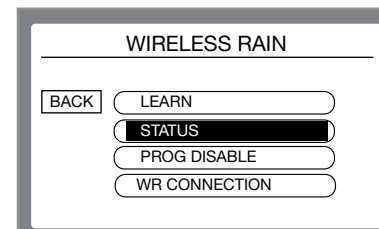

On the Status screen, displayed is:

- Rain Status
- Battery life of the WRFS
- Temperature last received from the WRFS
- Time of the last update received from the WRFS.

NOTE: The WRFS sends updates at different intervals depending on rain and temperature conditions.

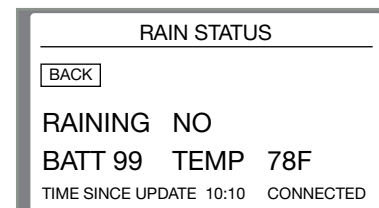

NOTE: To keep the wireless rain sensor inputs from operating on a particular program, see Program Disable, page 45.

PROGRAM DISABLE

The controller will also allow the user to use, or not use, the Rain sensors input on certain programs. Example: if you want the controller to take the rain sensor input into account for all programs except Program B, you can set the controller to ignore those inputs and run Program B just as you have set it, regardless of the rain events.

1. Use the ▼/▲ arrows to scroll to **PROGRAM DISABLE** and push **OK**.

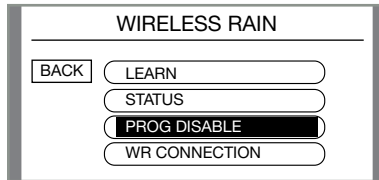

2. Use the ▼/▲ arrows to change the default **NO** to **YES**. Use the arrows to scroll down to the next program. **YES** means the run times will be effected, **NO** means they will not be effected.

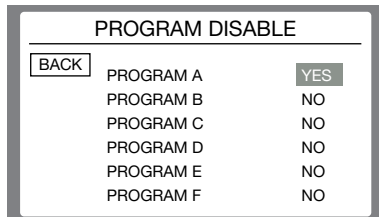

WR CONNECTION

This feature allows the user the ability to suspend the WIRELESS RAIN SENSOR inputs.

1. Use the ▼/▲ arrows to scroll to **WR CONNECTION** and push **OK**.

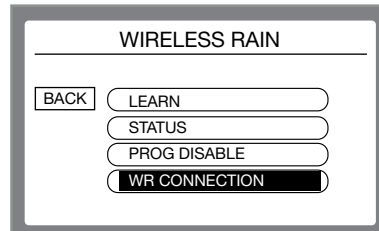

2. Use the ▼/▲ arrows to scroll to the desired setting and push **OK**.

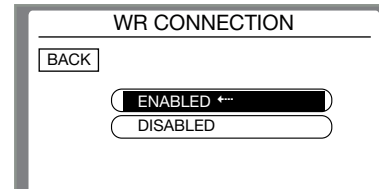

This is a Full Field program Display. This will show the days of the week associated with that program, # of scheduled start times and the time of the first start time.

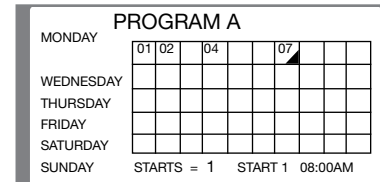
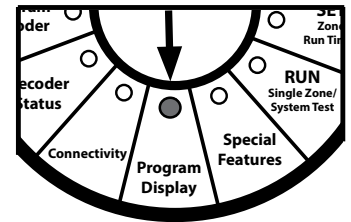

- Use the ◀▼▲▶ arrows to scroll the grid up and down to see all 99 zones. You can use the Program selection button to view the different program displays. Press **OK** to see other start times. This is what a typical display would look like.

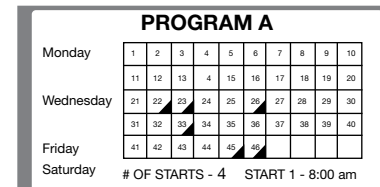

What can be seen from this screen is:

1. There are 46 zones with assigned decoders.
2. There are 6 zones (with assigned decoders) that do not have run times: 22, 23, 26, 33, 45, 46.
3. There are 4 scheduled start times in Program A.
4. The first start time will be at 8:00am.
5. The run days in this program are Monday, Wednesday, Friday and Saturday.

DECODER STATUS

GENERAL LOG

The general log is a list of EVERY action the controller makes. From turning a valve on to Faults recorded. This is a rolling 250 record list.

1. Use the ▼/▲ arrows to scroll to **GENERAL LOG** and push **OK**.

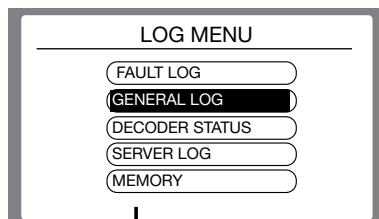
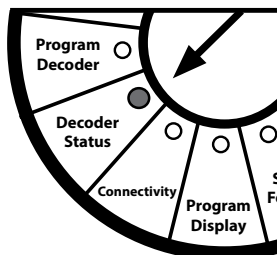

GENERAL LOG

LINE 001

| POS | LN | ACTN | OSS | IRSS | TIME | DATE |
|------|----|-------|-----|------|-------|----------|
| ZN04 | 2 | ON | 99% | 95% | 08:00 | 31/12/18 |
| ZN02 | 2 | ON | 99% | 95% | 08:00 | 31/12/18 |
| ZN01 | 1 | ON | 99% | 95% | 08:00 | 31/12/18 |
| ZN01 | 1 | ON | 99% | 95% | 04:09 | 06/12/18 |
| MOD | 2 | FAULT | | | 12:05 | 06/12/18 |
| MOD | 1 | FAULT | | | 12:05 | 06/12/18 |

EXAMPLE 1: This shows that Zone 4 is on line 2 and was sent an On command. The outgoing signal strength was 99% and the return signal strength was 95%. It was 8:00 on December 31.

EXAMPLE 2: This shows that there was a fault with the 2-wire module, line 2 at 12:05 on December 06.

The location of the event

The line it is on

If the Action was an on/off or a FAULT

Outgoing Signal Strength

Returning Signal Strength

FAULT LOG

The FAULT LOG is a snapshot of the GENERAL LOG. It is a way to quickly identify and isolate the faults showing on your controller. There is also an interactive service list on this page. This helps you identify which items have been addressed and what potentially still needs corrected.

1. Use the ▼/▲ arrows to scroll to **FAULT LOG** and push **OK**.

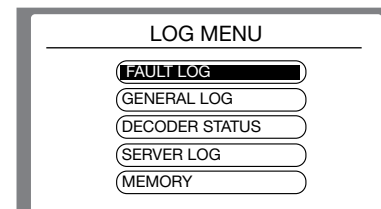

2. Use the ▼/▲ arrows to move the highlighted cursor down the list until you reach a selection you wish to change.

FAULT LOG

LINE 001

| POS | LN | TYPE | TIME | DATE | SERVICE |
|------|----|-------|-------|----------|---------|
| ZN04 | 2 | DECO | 08:00 | 31/12/18 | OPEN |
| ZN02 | 2 | DECO | 08:00 | 31/12/18 | OPEN |
| ZN01 | 1 | DECO | 08:00 | 31/12/18 | OPEN |
| ZN01 | 1 | DECO | 04:09 | 06/12/18 | FIXED |
| MOD | 2 | COMMS | 12:05 | 06/12/18 | FIXED |
| MOD | 1 | COMMS | 12:05 | 06/12/18 | OPEN |
| MOD | 1 | COMMS | 12:04 | 05/12/18 | FIXED |
| MOD | 2 | COMMS | 12:04 | 05/12/18 | OPEN |
| MOD | 2 | COMMS | 01:07 | 30/11/18 | FIXED |
| MOD | 1 | COMMS | 01:06 | 30/11/18 | OPEN |

3. Push **OK** to change the option from **OPEN** to **FIXED**. Push **OK** again if you need to change it back to **OPEN**.

DECODER STATUS

DECODER STATUS CHECK

This is another diagnostic tool. When you run a decoder status, the system will run each decoder for 15 seconds. Once complete it will give you a status, or health of the connection between the controller and each decoder. This diagnostic can be performed at any time during the life of a system.

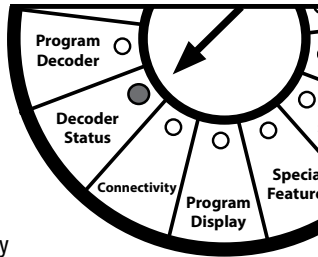

RUN NEW STATUS

1. Use the ▼/▲ arrows to scroll to **DECODER STATUS** and push **OK**.

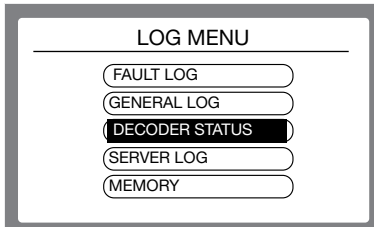

2. Use the ▼/▲ arrows to scroll to **RUN NEW STATUS** and push **OK**.

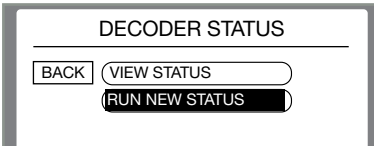

3. Push **OK**.

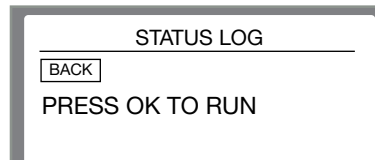

4. This screen will show while the test is running.

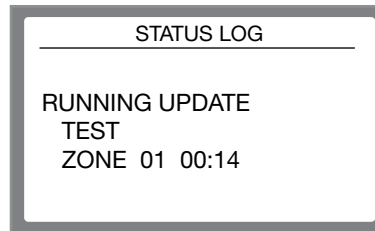

VIEW STATUS

Once you run a new status, go to **VIEW STATUS** to see the results. This will show you every decoder, the line it found it on, the outgoing signal strength and the return signal strength. This is a really easy way to make sure you are getting a good signal to each decoder. It can also narrow down the search for issues. Example: If zone 1 through 9 showed a good RSS, then zone 10 was very low or even 0%, you would know that zone 10 probable has a wiring issue, but if all the zones after 10 show 0% RSS, you know you have a potential break in the main 2 wire path between zones 9 and 10.

1. Use the ▼/▲ arrows to scroll to **VIEW STATUS** and push **OK**.

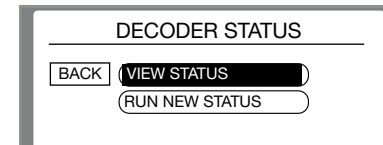

| POS | LN | ACTN | OSS | RSS |
|------|----|------|-----|-----|
| ZN01 | 1 | ON | 99% | 00% |

FAULT LIST

| FAULT | DEFINITION OF FAULT | POSSIBLE REASONS FOR FAULT | CONTROLLERS RESPONSE |
|------------------------------|---|--|--|
| Decoder Fault | The decoder has not acknowledged that it has received the data to perform its specific function. | <ul style="list-style-type: none"> • Main 2-wire line could be installed backwards at a given junction. • You may have a loose connection in your wiring somewhere between this decoder and the controller. • Serial number of the decoder was entered incorrectly. | For any of these fault conditions, the initial response of the controller will be to log the fault and continue on to the next station. If the error is given on 5 decoders in succession, the system will shut down until the issue is addressed. |
| O/L 2 Fault | There is a direct short on the 2-wire path. This fault is generally accompanied by its location. Example: if the display reads "Fault Module 1 O/L 2" that means there is a direct short on line 2. | <ul style="list-style-type: none"> • A direct short on the 2-wire path. | In this case the system will shut down until the next available start time. |
| O/L 1 Fault | The controller sent out power to test the line and detected a load across the 2-wire cable. This fault will also be shown with what line the fault was detected on. | <ul style="list-style-type: none"> • Example: A master valve was connected directly to the 2-wire cable without a decoder. | In this case the system will shut down until the next available start time. |
| Coil Fault or No Coil | The decoder was able to receive power and data, but if the decoder detects a short or non-response on the output side, it will show "Coil Fault." This fault will also show you what zone the fault was detected. Example: FAULT COIL ZONE 2 will show if you have an issue with the coil or solenoid assigned as zone 2. | <ul style="list-style-type: none"> • The solenoid has gone bad. • The wiring to solenoid is disconnected or corroded. | The controller will actually complete the assigned run time and once complete it will receive this error. NOTE: the system will show you which zone had a fault, unless it is running in a group, then it will simply display the first zone. |
| Comms Fault | This means you have no power to the 2-wire module in the controller. | <ul style="list-style-type: none"> • Fuse on the main panel is blown. • Overheated controller. • Hardware failure. | Shuts the system down until the issue is corrected. |
| Invalid Prog | The controller starts a program and notices you are over the 6 zone per line limit. | <ul style="list-style-type: none"> • You have exceeded the number of zones per line. | Controller will run first 6 zones available sequentially and not run any zones beyond those. Error will be displayed on screen but program will continue. |

2-WIRE MODULE STATUS LIGHT DEFINITIONS

1. FLASHING GREEN LIGHT

This means that the module is connected and functional but no program is currently running.

2. FLASHING ORANGE LIGHT

This means that the module is currently energized and sending power to the 2-wire line.

3. FLASHING RED LIGHT

This means that the module has experienced an O/L Fault. Action is required.

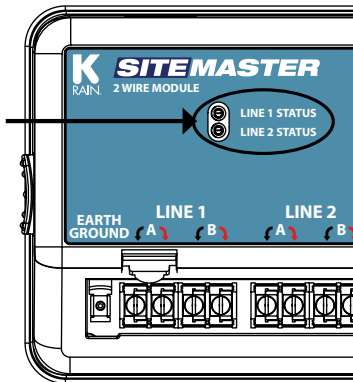

PUMP START RELAY / MASTER VALVE WIRING

This section is only for systems that require a pump start relay or master valve. The controller does not provide main power for a pump.

Master Valve or Pump Start Relay wiring terminals “Common” and “MV/PS” are located on the right side of the 2-wire module.

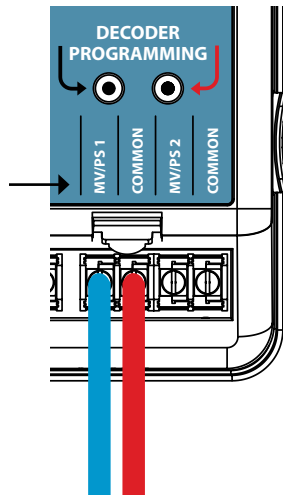

RAIN SENSOR INSTALLATION

All electrical connections and wiring must be made according to local building codes.

1. Open the cabinet door.
2. Open the front panel by grasping the finger- hold on the top right side of the front panel. Swing the panel open to the left.

3. Connect the two rain sensor wires to the two terminals marked RAIN SENSOR located in the upper right corner of the cabinet.

RAIN SENSOR TERMINAL

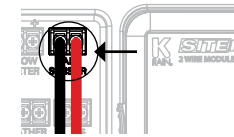

4. From the face of the midbox, push the Rain Sensor button to enable or disable the rain sensor functionality.

For wireless rain sensors needing an additional power source, use the VT terminal for 24VAC and use the COM terminal for the common. Both are located in the lower right of the terminal area.



Rain Sensor Bypass Select Button

REMOTE PROGRAMMING

The SiteMaster allows the user to program the controller with the main panel disconnected from the cabinet. The user must first install a 9V battery in the back panel to access this feature.

1. Open the cabinet door.
2. Open the main panel by grasping the finger-hold located on the top right side of the cabinet.
3. Locate the battery compartment on the rear of the main panel.



9V BATTERY FOR
REMOTE PROGRAM-

NETWORK MODULE CONFIGURATION

1. Connect the Network module to the back of the SiteMaster mid-box.



2. Use an ethernet cable to plug into the "pig tail" port that comes with the network module.



3. Turn the dial to "Connectivity".

The LCD screen will show this menu. Use "OK" button to select the "STATUS" option.

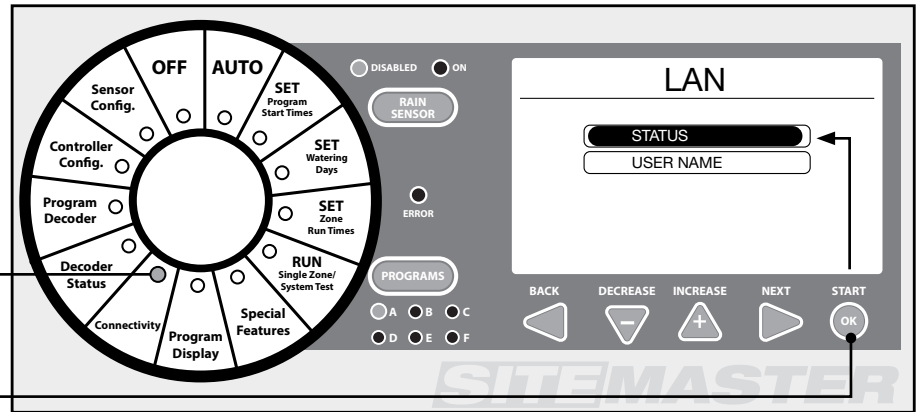

4. The LCD screen shows basic instruction for enabling the Network Module.

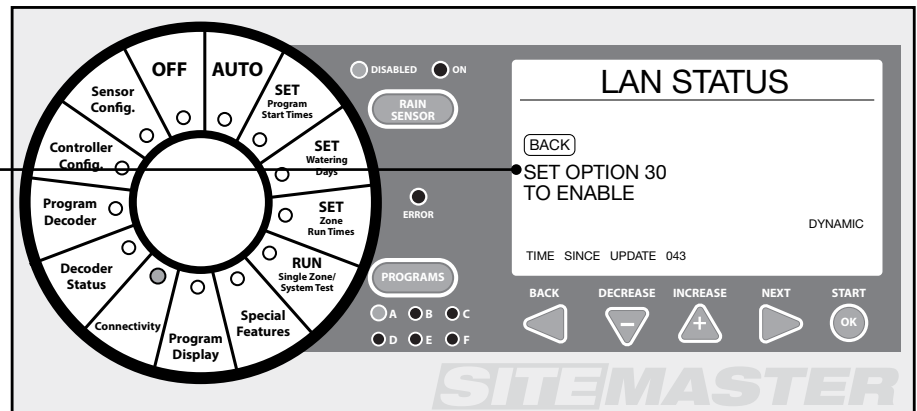

NETWORK MODULE CONFIGURATION

5. Turn the controller dial to “Controller Config”.
Use the DOWN button to scroll the menu until “Special Option 1”.

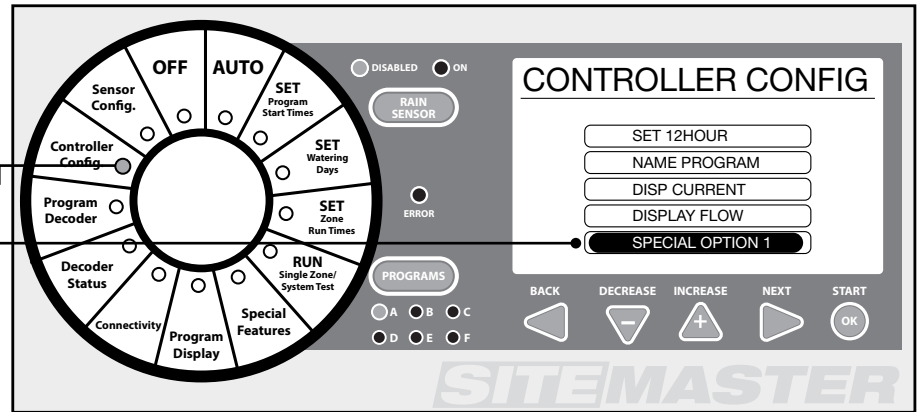

6. Enter “Special Option 1” then use the NEXT button to scroll down the list until “GSM LAN”.
Use the INCREASE button to change the value from 000 to 002.

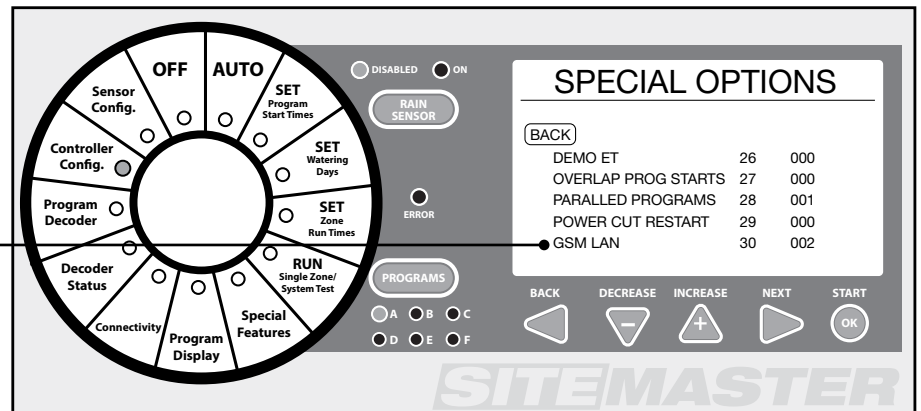

7. Turn the dial to “Connectivity” and select “User Name.”

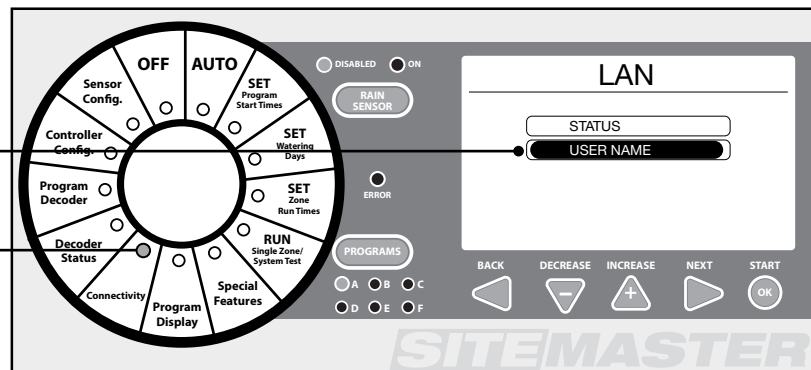

8. Enter the prepared “Server ID” number.
 - 7 digits “Server ID” will be assigned by K-Rain Manufacturing.

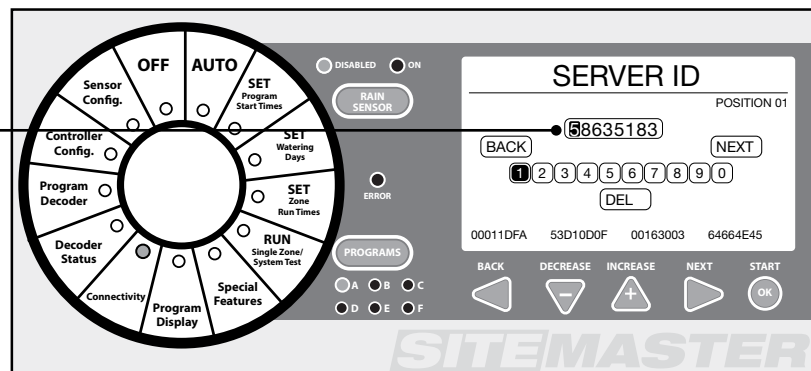

9. Connect the ethernet cable then restart SiteMaster, entering the “Connectivity” Status page to confirm the connectivity.
 - Use sitemaster.krain.com to access the online portal.
 - The customer will need to notify K-Rain Manufacturing their preferred username and password in order for K-Rain to create them.

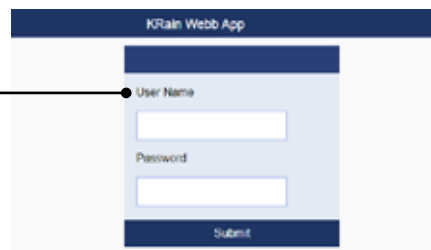

WARRANTY

The manufacturer guarantees to the original purchaser that any product supplied by the manufacturer will be free from defects in material and workmanship for a period of two years from the date of purchase. Any product found to have defects in material or workmanship within the warranty period shall be repaired or replaced by the manufacturer.

The manufacturer does not guarantee the use for a particular purpose of its products and does not make any guarantee, expressed or implied, other than the warranty contained herein. The manufacturer shall not be liable for any loss from use of the product or incidental or consequential damages to other parts of any installation of which this product is a part.

The warranty shall not apply to any equipment which is found to have been improperly installed, set up or used in any way not in accordance with the instructions supplied with this equipment, or to have been modified, repaired or altered in any way without the expressed consent of the manufacturer. This warranty shall not apply to any batteries or accessories used in the equipment covered under this warranty or to any damage which may be caused by such batteries.

If the controller develops a fault, the product or main panel must be returned in adequate packing with:

1. a copy of your original invoice;
2. a description of any fault; and
3. contact name and information.

It is the purchaser's responsibility to return the controller to the manufacturer or their agent by prepaid freight.



K-Rain Manufacturing Corp.

ATTN: WARRANTY
1640 Australian Avenue
Riviera Beach, FL 33404
(561) 844-1002
(561) 842-9493 FAX
(800) 735-7246 / www.krain.com

© K-Rain Manufacturing Corp.
AN ISO 9001 CERTIFIED COMPANY

KRAIN Manufacturing Corporation
Irrigation Sprinkler Controller

Hereby, K-Rain Manufacturing Corporation declares that this Sitemaster Irrigation Controller is in compliance with the essential requirements and other provisions of Directive 1999/5/EC.



IP 24 Certified

Certificate of Conformity to
European Directives